

Analysis and Comparisons of Cruising Multihulls 2013

by Calvin H. Markwood

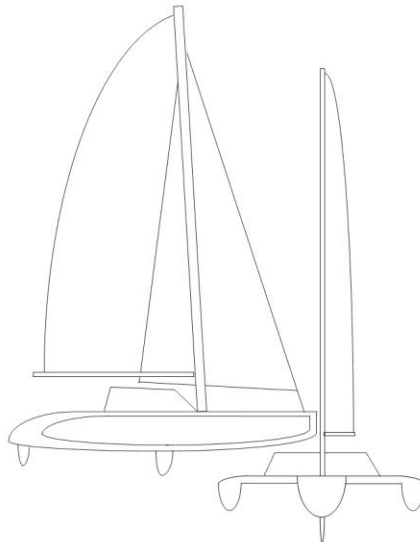

Table of Contents

<u>Introduction</u>	1
<u>Boat Data</u>	2
<u>Graphs</u>	3
Cruising Catamarans	4
<u>Analysis</u>	4
Hull Beam and Hull Length to Beam Ratio	4
Overall Beam and Beam vs. Length	6
Beam at Hull Centerlines and Bcl vs. Waterline Length	7
Displacement vs. Length	9
Displacement-Length Ratio	9
Prismatic Coefficient	10
Sail Area	10
Sail Area vs. Displacement and the Sail Area/Displacement Ratio	11
<u>Performance</u>	13
Performance Index	13
Bruce Number	13
Base Speed TM	14
S Number	15
S Number and Base speed Comparison	15
Texel Rating	16
Bridgedeck Clearance for Catamarans	18
<u>Stability</u>	20
Stability Index	20
Stability Speed	22
Cruising Trimarans	24
<u>Introduction to Trimaran Analysis</u>	24
Outriggers immersed while boat is at rest, or not	24
Large outriggers vs. small outriggers	24
Outriggers placed forward vs. centered	24
Outrigger displacement positioning	24
Outrigger shape	25

<u>Analysis</u>	26
Overall Beam and Beam vs. Length	26
Hull Beam and Hull Length to Beam Ratio	26
Beam at Hull Centerlines and Bcl vs. Waterline Length	27
Displacement vs. Length	28
Displacement-Length Ratio	28
Sail Area vs. Displacement and the Sail Area/Displacement Ratio	29
<u>Performance</u>	30
Performance Index, Bruce Number and Base Speed™	30
<u>Stability</u>	30
Stability Index and Stability Speed	32
Catamarans vs. Trimarans	33
Limitations and Missing Items	34
Potential Future Developments	34
Conclusion	35
Appendix A: Sail Center of Effort Derivation	A-1
Appendix B: Stability Index Derivation	B-1
Appendix C: Graphs for Database of 750 Cruising and Racing Catamarans	C-1

Introduction

Since the 1990s, boating magazines have contained a great amount of facts and figures about modern cruising multihull sailboats - catamarans and trimarans. I am fascinated by sailboats, especially multihulls, and wondered what I could learn by analyzing the data that was available about them. This curiosity prompted me to dig out a book published by the Amateur Yacht Research Society in 1976 entitled "Design for Fast Sailing", by the late Edmond Bruce and Henry A Morss, Jr. Bruce was a very practical and highly analytical yacht design hobbyist who, along with other AYRS members, was seeking the ideal yacht design that was both fast (fun) and stable (safe). I also sought information on classical boat design from Skene's Elements of Yacht Design and other books.

After refreshing my memory on principles and equations from these sources, I used the data, augmented with some assumptions where data was missing, and did a comparison of 36 of the catamarans. This work was published as "Ratios and Cruising Catamarans" in Multihulls World no. 23, April/May 1994.

As time went on, I added data for a total of over 100 cruising catamarans from various magazines, revised the analysis and submitted it for publication as "Theory and Statistics for Cruising Multihulls" in Multihulls Magazine vol. 23, no. 2, March/April 1997.

Curious about what some prominent designers were doing, I repeated the analysis on several of the designs of Lock and Brett Crowther, Kurt Hughes, Derek Kelsall and John Shuttleworth as published in their respective design books. This work was published as "Four Kinds of Cats" in Multihulls Magazine, vol. 25, no. 1, January/February 1999.

I have since received feedback from several people who were in the process of buying cruising catamarans indicating that the analysis was useful to them in sorting fact from fiction in brochures and marketing material. There is a legitimate complaint that designers and manufacturers do not disclose information comparing their boats with those of their competitors. And I think there is another legitimate complaint that boat magazines do not press their advertisers to provide comparative information, nor do they do valid comparisons in sail-offs at boat shows and other gatherings. Race results are informative, but can be misleading with respect to crew skill, boat preparation and outfitting, etc. Really valid, controlled comparisons are just not readily available. So an analytical tool is understandably useful.

I also got feedback from the articles on analytical methodology, especially with regard to performance and stability. For the article in the 1994 Multihulls Magazine, I derived a performance index that considered sail area, displacement and length. For the 1999 article, I used a similar index by Derek Kelsall called the Kelsall Sailing Performance Number. Richard Boehmer wrote to me after that article and offered an index called "Base Speed^{TM,1}", an empirically-derived indicator of the distance a given boat could travel in 24 hours under a variety of conditions. It can be used to compare speed potential of one or more boats and has been used for handicapping boat races involving a variety of boat types. The widely-used Texel Rating is a derivative of it.

Another index I derived from first principles was a capsizes stability index that considered sail area and arrangement, displacement and beam. This appeared in the 1997 MM article. I refined the index to use the spacing between the centerlines of the hulls rather than overall beam for the 1999 MM article, but found that beam centerline data was

¹ "Base Speed: A Simple Measure for Estimating Multihull Performance" by Richard Boehmer, Multihull International, No. 225, April 1989 pp. 108-110.

nearly impossible to obtain. So I scaled drawings in magazines for an approximation that will allow boat-to-boat comparisons. John Shuttleworth in “Multihull Designs” by John Shuttleworth Yacht Designs, Ltd., 1998 presents a similar formula for static stability in flat water and says it gives the wind speed at which a boat has to reduce sail. These formulas are presented in the discussion to follow.

Until this present revision of my work, I have avoided trimarans. There is a complexity to trimarans that doesn't exist with catamarans, i.e., the outriggers. There is such a wide variety of approaches to designing the outriggers of trimarans that I have been hesitant to perform even a first order comparative analysis as I have done with catamarans. After all, the two hulls of a catamaran are always either identical or mirror images of each other. However, I have included a chapter here for trimarans, with the analysis based on the main hull and the assumption that the main hull is designed to carry the full displacement of the boat. Analysis of the outriggers is ignored. More on this in the chapter on Cruising Trimarans.

A qualifying statement must be made about the analysis used here. It's precision is limited by the lack of precision in the basic data available on the boats. Advertised weights and displacements are questionable. Area used for the sails is for the main and 100% fore-triangle as much as possible. Height of the center of effort of the sails and distance of hull center of effort below the waterline are rarely available, so they are approximated for stability index calculations². Hull design and the layout of hull lifting devices (keels, centerboards, daggerboards, outriggers of trimarans, etc.) can significantly affect many performance matters. However, details about them are rarely available and so are not considered in the analyses.

Nonetheless, first order evaluations can certainly be done with the data and analysis available, so read on.

Boat Data

The credibility of the specifications for analysis and comparison is a serious issue. The tables and graphs contained in this article are the result of years of data gathering and analysis. In the database, the lengths, overall beams, displacements and sail areas came from magazines and the design books and web sites of various boat designers and sellers. Length at the waterline (Lwl), hull beam (Bh) and beam at hull centerlines (Bcl) had to be estimated for most boats, since they were not usually stated.

Many of the designers have been responsive to e-mail requests for some of the missing or questionable data. Lwl and Bcl were scaled from photos and drawings in many cases. Hull beam, and thus hull length-to-beam ratio, were estimated as discussed below if not provided by the sources.

Displacement has been one of the toughest specification items to pin down. The goal for this analysis has been to use design displacement...the displacement that floats the boat at the design waterline. The figures presented in magazines and web sites may be bare boat weight, empty weigh or maximum weight. There is more credibility in the displacement figures for newer boats than for older ones, since many of them come from the designers on direct request.

Another specification that has been difficult is sail area. The goal has been to use the areas of the main and a jib that represents 100% of the foretriangle. When the data

² See Appendices A and B

contains an overlapping jib or genoa, 2/3 of this area has been used for analysis and comparison.

Graphs

The graphs placed in the catamaran chapter show data points for only a small sample from the database to illustrate the various parameters being discussed. Graphs showing the catamaran database of approaching 1000 boats are included as Appendix C. The graphs in the trimaran chapter include data points for the over 125 boat data base. Boats mentioned in the article are highlighted on the graphs. Trend lines included in the graphs represent the entire database of cruising and racing catamarans and trimarans in their respective sections of the article.

The trend lines on the graphs are chosen according to the characteristics of the parameter being graphed. For example, sail area increases in proportion with the square of length, so a “power of two” curve is inserted into the chart showing sail area vs. length. Displacement increases as the cube of length. Sail area increases to the 2/3 power of displacement, etc. The software used for the graphs is able to create these “power type” trend lines in most cases.

Cruising Catamarans

Analysis

Where to start in discussing analysis of boats is always difficult to decide. If a person is buying a boat, he usually starts with a boat size if price is no object or with boat price if it is. And he always wants about four feet more boat than he can afford. And he always needs about four feet more boat than he gets for all the stuff he, his crew and his passengers will want to carry on it. And he wants it to be fast but safe.

Much of the discussion to follow emphasizes the speed potential of the boats. Speed is not always the top priority of boat designers, even for multihulls. Sometimes safety or accommodations or other factors predominate. Where boats appear to differ from the norm, it is likely that these compromises have been made...there is no intent to criticize them.

Ignoring money for the time being (not an element in this analysis anyway), boat length and weight are usually drivers. Sometimes, overall beam is a driver where mooring or storage in a specific slip or location are constraints. Realistically, the payload begins to determine the length of boat necessary to carry it. For a given overall weight (boat weight plus payload), a short boat can require wide hulls, where a long boat can offer slender hulls. And slender hulls are what matters for good performance. So the analysis discussion will start with hull width or beam (for a single hull, not the whole boat) and the ratio of hull length to hull beam, both measured at the waterline.

It is essential to state here that the analysis and discussions that follow pertain to displacement hulls, not to planing hulls. Some catamarans (and many trimarans) are capable of planing, so their performance may exceed what is predicted here.

Hull Beam and Hull Length to Beam Ratio

A very significant factor in boat performance is the ratio of waterline length (**Lwl**) to hull beam (**Bh**) (not overall beam), **Lwl/Bh vs. Length**, plotted in Fig. 1 below. In Bruce and Morris' work "Design for Fast Sailing", it was shown that a good performing cruising catamaran or trimaran (main hull) should have a ratio of at least 8. In displacement hulls, the bow wave includes a trailing trough that a boat stern tends to set down into, limiting the speed of the boat. This is called "hull speed." Slender hulls, those with Lwl/Bh ratios greater than 8, do not create a large enough bow wave for this to be an appreciable effect³.

The high performance Polynesian style cats designed in the 1950s and 1960s by Rudy Choy and others had ratios of 14-16 and thus were very fast. Many other multihulls in that same period were slow, sea-going "apartment houses," where designers and builders sought to include the amenities of large cruising boats. Their Lwl/Bh ratios measured in at 7-8. Bruce's work clearly showed that, for good performance in a cruising boat, 8 was about as low as you should go. To achieve 14-16, the boat must be very light and some (most?) of the niceties of living must be left out. In between is where good cruising catamaran designs lie. Racers Lwl/Bh ratios lie above about 12.

³ A discussion on the effect of bow wave on boat performance may be found in "Sailing Theory and Practice" by C. A. Marchaj, Dodd, 1964, Mead & Company, New York

Fig. 1 L/BH vs Length

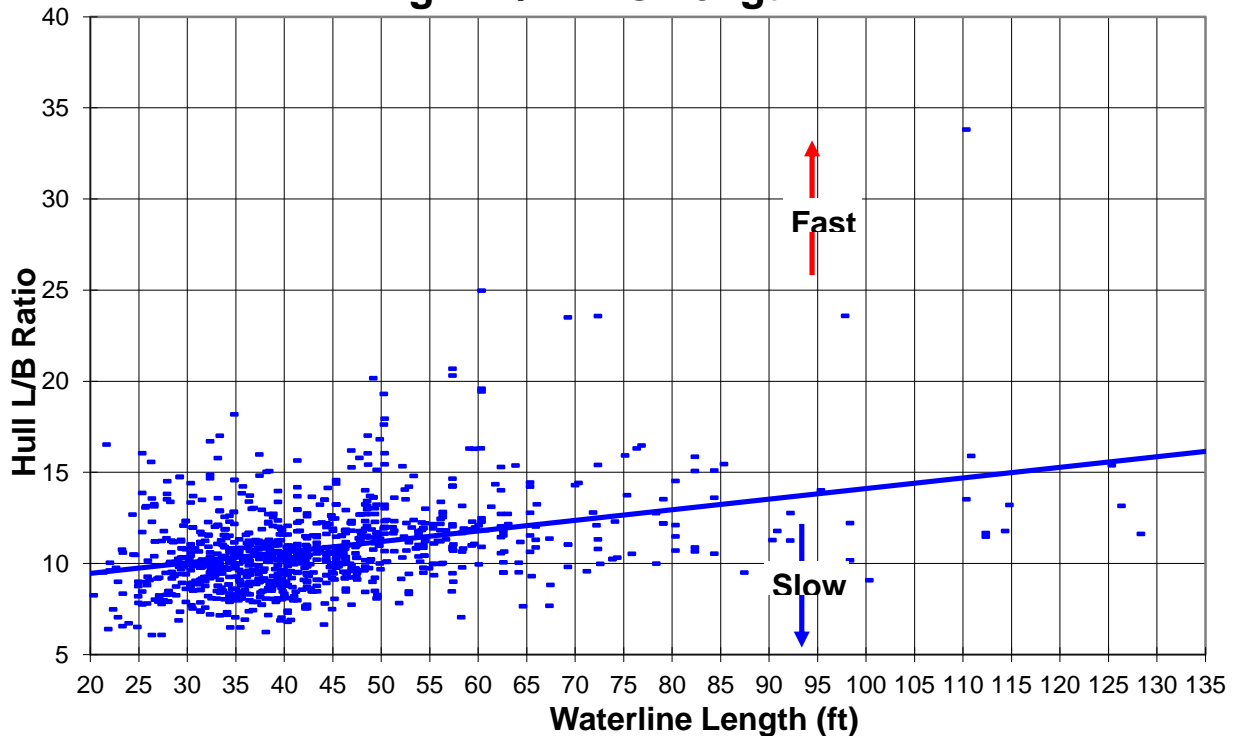

Hull beam of the modern cats was not given in the magazines, but subjective performance often is. So an analytical approach was needed for comparisons to be made. Novara 44 was picked as a high powered boat that appeared to be a good performer and a length to hull-beam ratio of 12 was assigned to it. This choice was based on the comments about Novara 44 and many of the other boats described in the magazines.

Lwl/Bh ratios for other boats were then calculated by assuming that all had semicircular underwater cross sections and could be scaled from Novara's results using the principle that the displacement was proportional to the length and the square of the hull beam. Hull beam for other boats was thus the square root of the displacement divided by the waterline length, or $Bh = Bh_{N44} * (D * Lwl_{N44} / D_{N44} * Lwl)^{0.5}$ ⁴, or with Novara's actual values inserted, $Bh = 9.85 * (D/Lwl)^{0.5}$. The way this number should be viewed is that, while possibly not the actual Bh or Lwl/Bh, a given boat should perform relative to other boats in proportion to the numbers. In other words, if two boats of the same length have the same sail area but one has a greater displacement than the other, the boat with an Lwl/Bh of 11 should be faster than the heavier one with Lwl/Bh of 10.

As the chart **Lwl/Bh vs. Length** shows, there is a wide variation from under 7 to over 14 in the catamarans analyzed. (This is especially apparent in the chart in Appendix C.) A trend upwards as boat length increases is apparent, reflecting the challenge of including cruising accommodations is easier in longer boats than short one...short boats must have beamier hulls to carry the necessary weight. The majority do fall in the 8-12 range suggested by Bruce as best for cruising cats.

⁴ The notation use throughout the article is that of a quantity (D/Lwl) raised (^) to the power shown (0.5).

The semicircular cross section assumption is probably not too great a stretch. Much of the development work done by members of the Amateur Yacht Research Society showed that this shape minimized wetted surface drag at low speed and was a good shape at high speed, so it is used or approximated by many of the catamaran designs.

When examining a boat or design, observations should be made of hull shape and judgments can be applied. For example, if a boat has wide, shallow hulls, the formulas above may understate the hull beam and give a more favorable estimate of relative performance than is justified. Or deep, boxy hulls may give lower light air performance due to their greater surface area and thus drag.

Some boats may be treated unfairly in this Lwl/Bh calculation. Catflotteur 41, for example, appears from photos in the magazines to have deep V hulls and possibly a higher Lwl/Bh ratio than with the calculations show. Other boats may also be considerably off semicircular. However, to permit analytical comparisons, an assumption in the absence of specifics of each boat must be made.

Most boats for which actual Bh figures have been obtained are very close to the estimates using this method. The gents at Catana sent actual hull beam figures for several of their boats and they were generally smaller than calculated by a few percent. It is apparent that their designer, the late Lock Crowther, has used a hull shape that is rounded, but deeper and narrower than a semicircular cross-section, i.e., they have a slightly lower Bh than calculated. That is a good design trade to slim the hulls but retain displacement, but at the sacrifice of some additional wetted surface...a trade that sacrifices low speed (light wind) performance for high speed performance. The slimmer hulls will also have a lower water-plane area, so they will immerse more with added weight. Other designers tend to flatten the shape toward the stern to achieve a planing hull, so their Bh may be wider than calculated.

Ask the designer to explain how his design differs from semicircular and why this is good. For example, the Farrier trimarans appear to have lower Lwl/Bh ratios than their impressive speeds suggest. They are probably achieving planing speeds and operating beyond the phenomenon of displacement hulls.

Overall Beam and Beam vs. Length

One feature of recent catamaran design is the significantly wider overall beam for the boats than for those built in the 1950s and 60s. In those earlier days, an overall beam-to-length ratio of 40 percent was common, although studies at that time were showing that 50 percent was better to avoid drag-producing wave interference in the tunnel between the hulls. The boats listed are predominantly in the 50-60 percent range, as shown in **Fig. 2 Boa-Loa Ratio**. Modern construction materials and methods have allowed the relative increase in beam without an unacceptable weight penalty. The wide beam of these newer boats should provide lateral stability margin that can be used either for increased sail area or safety, or both. A few of the boats go over 60 percent.

Fig. 2 Overall Beam/Length Ratio

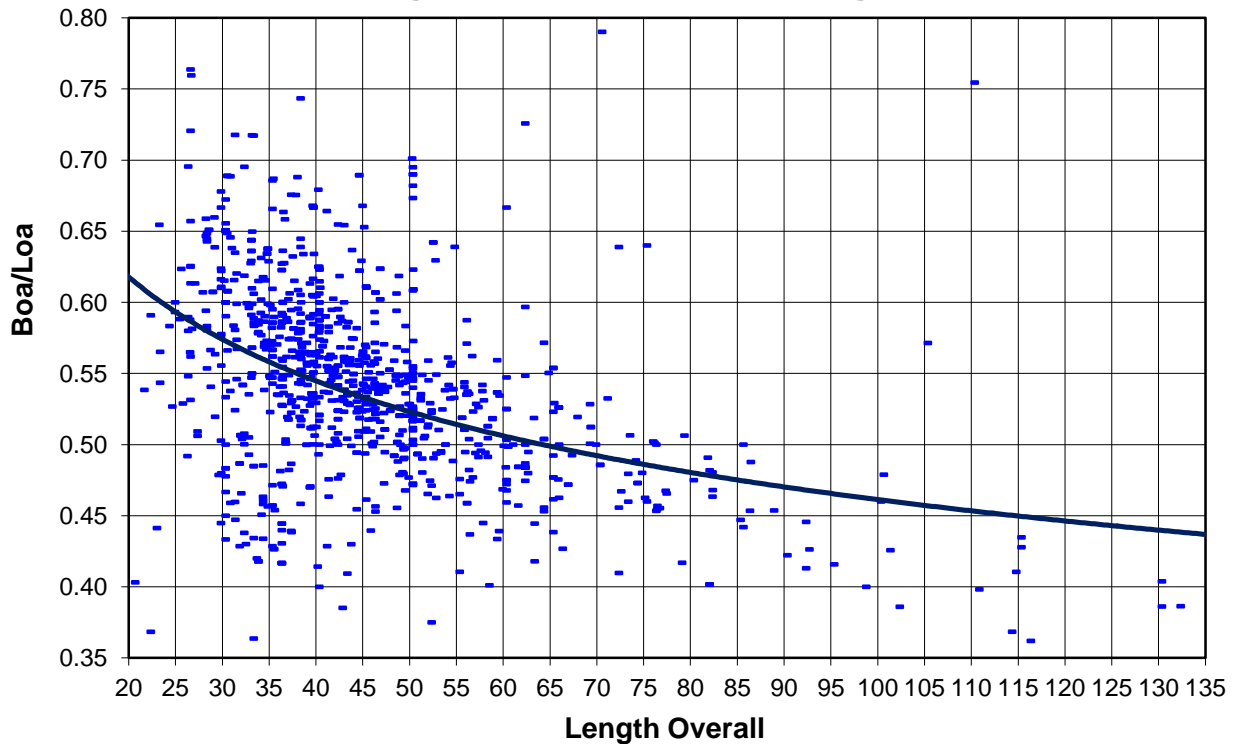

Beam at Hull Centerlines and Bcl vs. Waterline Length

Considering, however, the part of boat that actually makes waves, the underwater part, this evaluation should really be based on the Bcl-Lwl ratio (beam at hull centerline/load waterline). And a crude conversion suggests that this ratio should be 40 percent or greater to avoid the drag associated with wave interference. This is shown on **Fig. 3 Centerline Beam/Waterline Length Ratio**.

Fig. 3 Centerline Beam/Waterline Length Ratio

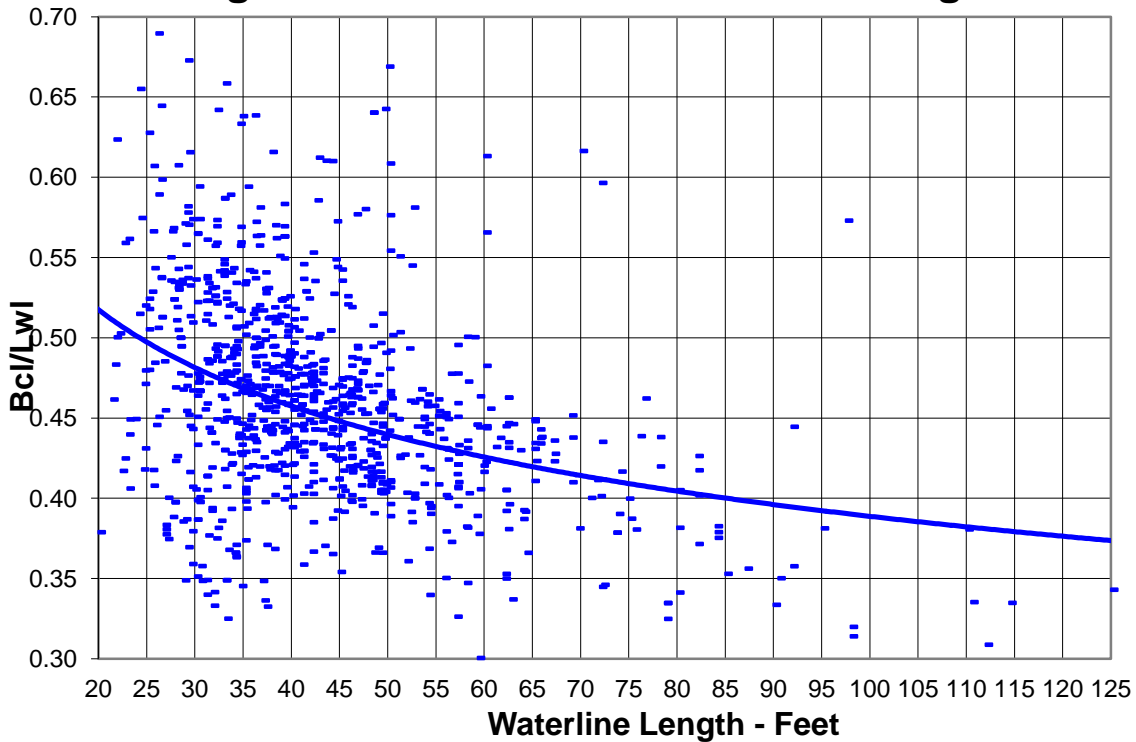

It should be noted that the smaller the bow wave a boat hull makes, the less hull spacing matters. (The benefit of slender hulls for overcoming the hull speed effect was cited earlier.) The phenomenon involved is two bow waves adding together to make a larger combined wave between the hulls.

Specific boats will shift in their positions from the *Boa/Loa* chart to the *Bcl/Lwl* chart. For example, many of Shuttleworth's boats flare significantly above the waterline, giving interior space in the hulls without sacrificing slenderness at and below the waterline. Their *Boa/Loa* ratios are quite large. Other boats that have significant bow and stern overhang will have deceptively small *Boa/Loa* ratios, looking longer and slimmer in plan view. James Wharram's boats are examples. The *Bcl/Lwl* ratio, however, gives the true picture of the portion of the boat that is in the water for performance and stability considerations.

It's interesting to note on this chart in Appendix C the narrowing of the spread in this ratio from the shorter boats to the longer ones. In the shorter boats, the ones with high numbers are racers, with minimal cruising accommodations. The ones with low numbers probably show the struggle to get cruising accommodations into small boats without adding the structural weight that extra beam contributes.

Displacement vs. Length

Figure 4 shows **Displacement vs. Length**. Trend lines for displacement vs. length should follow a length-cubed relationship...double the length of a boat, the displacement should increase by two cubed, or eight. Five trend lines relating displacement to length for hull-length-to-beam (Lwl/Bh) ratios of 9 through 13 are superimposed on the data because performance relates heavily to this ratio, as discussed above. The trend lines can be used as follows: if a reader is interested in true cruising boats, he should investigate those near the Lwl/Bh = 9 curve. If a cruising-racer, investigate near the 10-11 curve. If a racing-cruiser, 12 or higher.

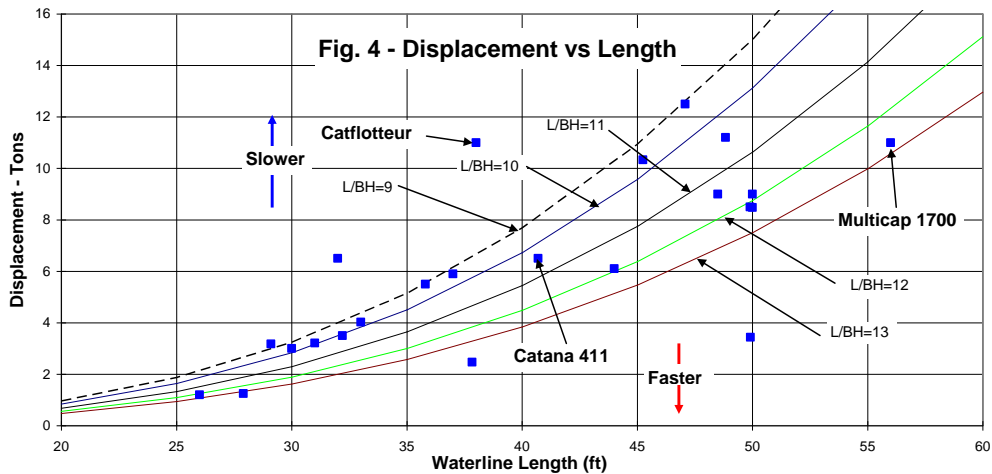

There are some marked differences among the boats listed. Boats represented by marks above and to the left are heavier, while those down and to the right are lighter. For example, of the boats near 41 feet in overall length, Catflotteur 41 at 11 tons displacement (Lwl/Bh ratio of 7.13) must be a slower boat than Catana 411 at 5.5 tons (Lwl/Bh ratio of 10.3) since speed varies directly with hull slimmness and inversely with displacement. Similarly, comparing the 41.3 foot Catflotteur 41 with the 56.4 foot Multicap 1700, both at 11 tons, we can suspect that Catflotteur 41 is somewhat sedate in performance and Multicap 1700 potentially exciting. But displacement and hull Lwl/Bh are not the only factors that determine performance.

Displacement-Length Ratio

Another performance factor derived from Bruce's work and from classical marine engineering is displacement-length ratio, the ratio of displacement of the hull to its length (divided by 100) cubed, or $(D/2*(0.01*Lwl))^3$. The two (2) in the denominator is to divide the displacement into the two hulls of a catamaran; it will not appear in the equation for trimarans. This is plotted in the chart **Disp-Length vs. Length**. Bruce showed performance using the speed-length ratio (V/L) and speed-weight ratio (V/D) but this speed-related data was not available. However, the displacement-length ratio provides the same insight, reflecting how slender or tubby the boat really is.

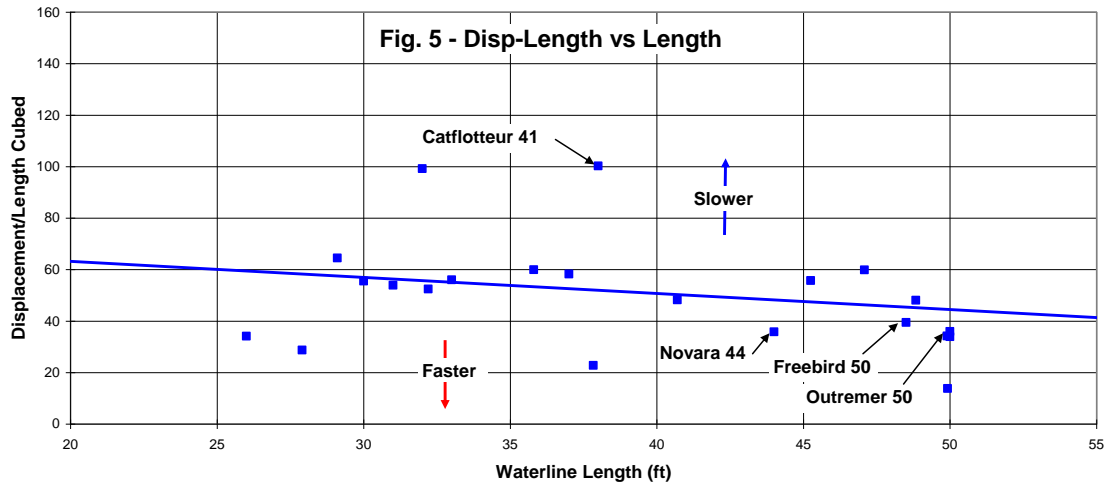

Two boats can have the same hull length-to-beam ratio (Lwl/Bh), but the one with the smaller displacement-length ratio will have less abrupt entry and exit, and should be faster (in a displacement mode). Think of a slender boat vs. a log half submerged. Boats with this ratio below 50 appear to be biased toward speed, and those above 50 toward cruising comfort. (Note: these numbers must be doubled for monohulls or the main hull of a trimaran.) There is an interesting downward trend in the chart from smaller to larger boats. It suggests that the smaller boats are proportionately heavier for their length. The reason, as stated before, is that they must be huskier to carry cruising accommodations and payloads.

Catflotteur 41 at 100 for this index appears to be significantly overweight, probably showing its 1950s design character. It is described in one article as "comfortable to sail" and "heavy loaded for long cruising". On the other hand, the Outremer 50, well below the 50 line at 34, is described by words like "surprise" and "powerful". Novara 44 and Freebird 50 also appear to be sleek boats by this comparison.

Other writings on this ratio lend credence to the statements above. *Skene's Elements of Yacht Design* by Francis S. Kinney says boats with higher ratios have lower total resistance at lower speeds...hinting that the shorter you make a boat of a given displacement, the less wetted surface you have, with the limit being a hemisphere. *Sailing Theory and Practice*, by C. J. Marchaj says boats with a ratio below 150 are potentially planing boats, while those above that number are non-planing, or displacement, boats. Of course, Marchaj was talking about mono-hulls, so the number is double that of a catamaran.

Prismatic Coefficient

Prismatic coefficient is the ratio of the displacement (expressed in cubic feet) to the area of the largest underwater cross section times the Lwl . Unfortunately, the method used in the analysis to approximate Lwl/Bh ratios made these coefficients identical. Real hull design data would make this a meaningful item to calculate and compare.

Sail Area

The sail area data in **Fig. 6 - Sail Area vs. Length** follows well as the square of length trend line, but again a scatter from boat to boat at any given length is clearly visible. For

example, Outremer 50's sail area is comparatively large and Quasar 50's is comparatively small for two boats nearly the same size and displacement. For given conditions, Outremer 50 should be much faster (more on "faster" later under performance). Shuttleworth's Tektron 35 and Shuttle 40 plus several of the other 50 foot boats are powerfully rigged. Interestingly, the Catflotteur 41 is as well, but recall that this boat is very heavy.

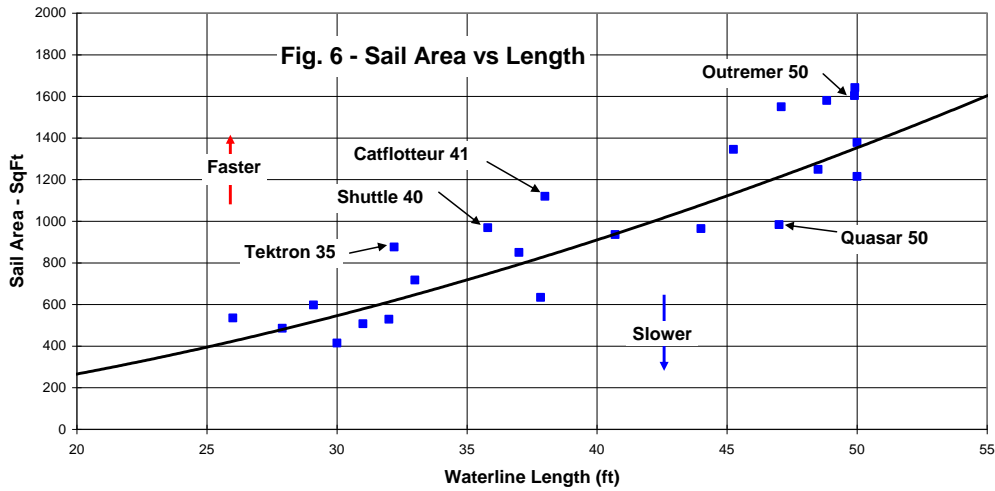

Sail Area vs. Displacement and the Sail Area/Displacement Ratio

But sail area should not be considered by itself. Another important item is how much boat (weight and drag) the sail has to push. Sail area is plotted against displacement on the **Fig. 7 - Sail Area vs. Displacement** chart. The highlighted boats will be discussed below.

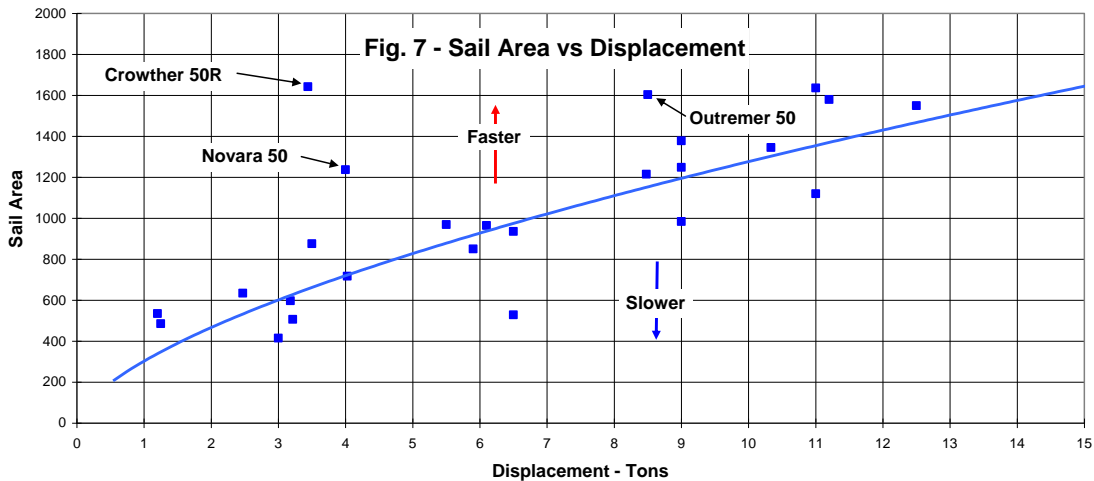

This chart is not as revealing as the following one, **Fig. 8, SA/D vs. Lwl.**

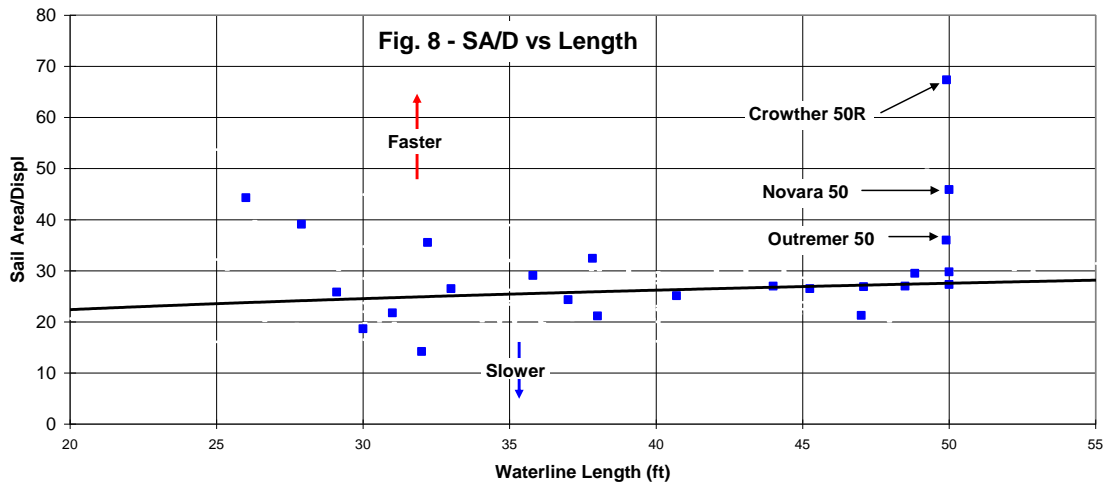

The ratio of sail area to displacement, SA/D, is roughly analogous to power-to-weight ratio for an automobile or thrust-to-weight ratio for an airplane. It should indicate the ability of the boat to accelerate and will affect top speed as well. The formula for this ratio is $SA/D = SA / (D * 2240 / 64)^{2/3}$. In the calculation, the number 2240 converts the displacement number to pounds, the 64 is the density of sea water in pounds per cubic foot and the exponent converts dimensions of the denominator to square feet, so the final number is dimensionless (feet squared divided by feet squared).

The trend of sail area (feet squared) divided by displacement (feet cubed) should scale with length by the 2/3 power, so, as before, the trend lines on the charts are “power” type. A direct comparison of sail area and displacement, expressed as a ratio, can be made from this figure. The higher the number, the faster the boat, other things being equal. For example, Novara 50 with SA/D = 45.88 should be significantly faster than Outremer 50 with SA/D = 35.99. The Crowther 50R is clearly a racer. (Performance calculations, discussed later, show this difference as well.)

On the **SA/D vs. Length** chart in Appendix C, the data points for two of the four smallest boats, Cheetah and KL28, suggests that they are only nominally "cruising" boats, light weight and highly powered. They appear to be day sailors, or indeed racing boats, with modest cruising accommodations. If more data were available, say for some of the Formula 28 or larger racing cats, I suspect the Cheetah and KL28 would fit a trend line for that family of boats better than for the bulk of these cruising cats. Other boats also appearing well about the “pack” are also racing-cruiser types.

Performance

Performance Index

Derek Kelsall of Kelsall Catamarans has presented a performance metric that presumes that performance is proportional to the square root of the factor length (LWL) times sail area divided by displacement, or $\text{Performance} = 0.5 * ((\text{SA} * \text{Lwl}) / (\text{D} * 2240))^{0.5}$. This figure gives an estimate of the relative boat speed to wind speed on a reach, i.e., a figure of .8 says a boat should do 8 knots in a 10 knot wind. The values are shown **Fig. 9 - Performance Index**. Note the positions of the three 50 foot boats discussed earlier.

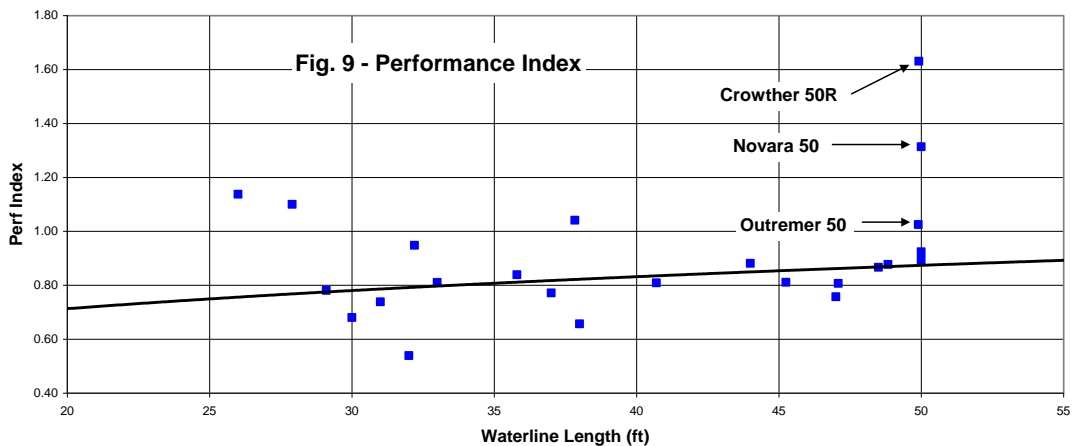

Bruce Number

The late Edmond Bruce developed the Bruce Number as an indicator of boat performance in light air. The formula is $\text{BN} = \text{SA}^{0.5} / (\text{D} * 2240)^{0.333}$. (Note that this is really just the dimensionless form of the Sail Area to Displacement ratio discussed earlier.) Chris White gives ranges for the Bruce Number reflecting whether a boat is an all out racing design (BN = 2 or more), a conservatively rigged cruiser (1.0-1.1) or a boat that is under-rigged to the extent of feeling “very sluggish” in light air (less than 1.3)⁵. Using these as a starting point, the accompanying **Bruce Number** chart shows ranges as follows: Less than 1.3, conservatively rigged; 1.3-1.6, modestly rigged; 1.6-2.0, performance rigged and greater than 2.0, racers. This tends to fit the descriptions of most boats.

⁵ “The Cruising Multihull” by Chris White, p. 54, International Marine, 1997

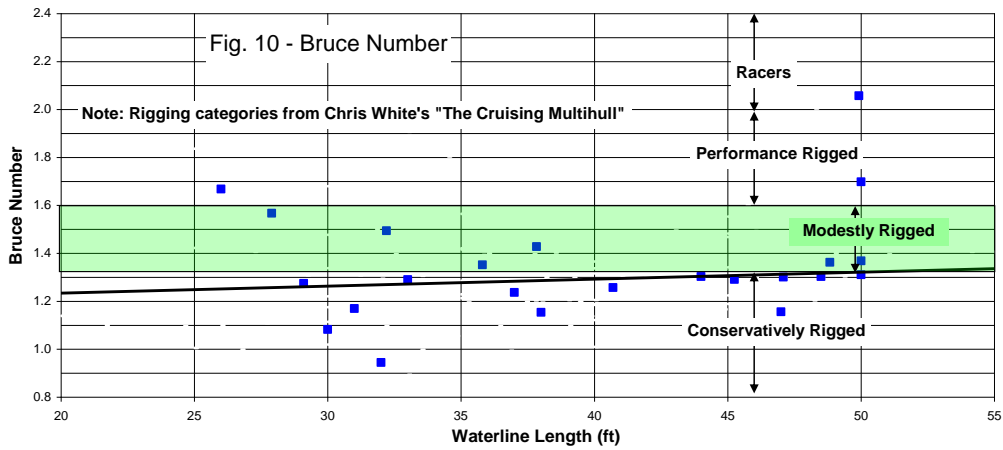

Base Speed™

As mentioned earlier, Richard Boehmer has developed a performance index called **Base Speed**, an empirically-derived indicator of the highest average speed (best day's run) a boat would attain over 24 hours under a variety of conditions. It can be used to compare speed potential of one or more boats and has been used for handicapping boat races involving a variety of boat types.

Boehmer derived this index by fitting actual race data of hundreds of boats to the formula $BS = a \cdot L^b \cdot SA^c / D^d$. He found $a = 1.88$, $b = 0.5$, $c = 0.333$ and $d = 0.25$. His resulting equation is $BS = 1.88 \cdot Lwl^{0.5} \cdot SA^{0.333} / D^{0.25}$, with the results expressed in miles per hour. It is shown on the chart **Base Speed**, with the constant $a = 1.7$ for results in knots.

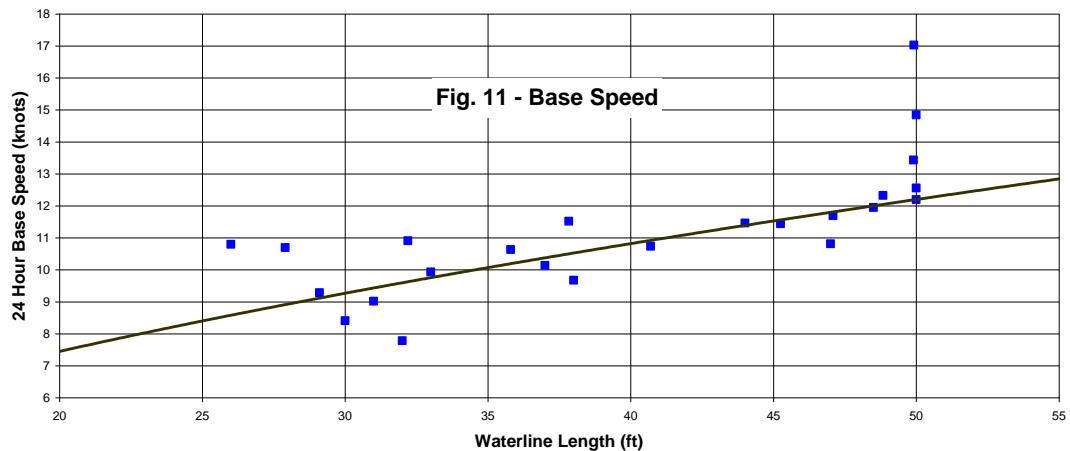

In an excursion of the analysis, the cruising catamarans in the database were separated from the racing cats using $Lwl/Bh = 12$ as the dividing line between the types. The **Base Speed** trend line for the racers was from $1\frac{1}{2}$ mph higher for the shorter boats to $1\frac{3}{4}$ mph higher for larger boats. This is approximately 15 percent.

One criticism of this index is that it is derived from the performance of good boats and bad, well sailed and not, and thus is not pure science. However, it gives a more intuitively more satisfying result than the Kelsall and Bruce formulas.

S Number

The S Number is a formula that assesses relative performance of sailing yachts, giving values that range from 1 to 10, with sub-ranges of these values assigned to Racing Machines (5-10), Racer-Cruisers (3-5), Cruisers (2-3) and Lead Sleds (1-2). It appeared in the February/March 2011 issue of *Professional Boatbuilder* magazine, the ROVINGS section by Dan Spurr, there was a summary of a section of “The Design Ratios” by Eric w. Sponberg of SPONBERG Yacht Design Inc. dealing with the S Number.

The formula is: $S\# = 1.52 \times 10^{[-DLR/526 + 0.691 \times (\log(SAD)-1)^{0.8}]}$

DLR in the formula is Displacement-Length Ratio and SAD is Sail Area/Displacement Ratio. For monohull sailboats, the 1.52 scaling constant needs to be changed to 3.972.

S Numbers are shown in Fig. 11a below:

Fig. 11a - S Number vs. LWL

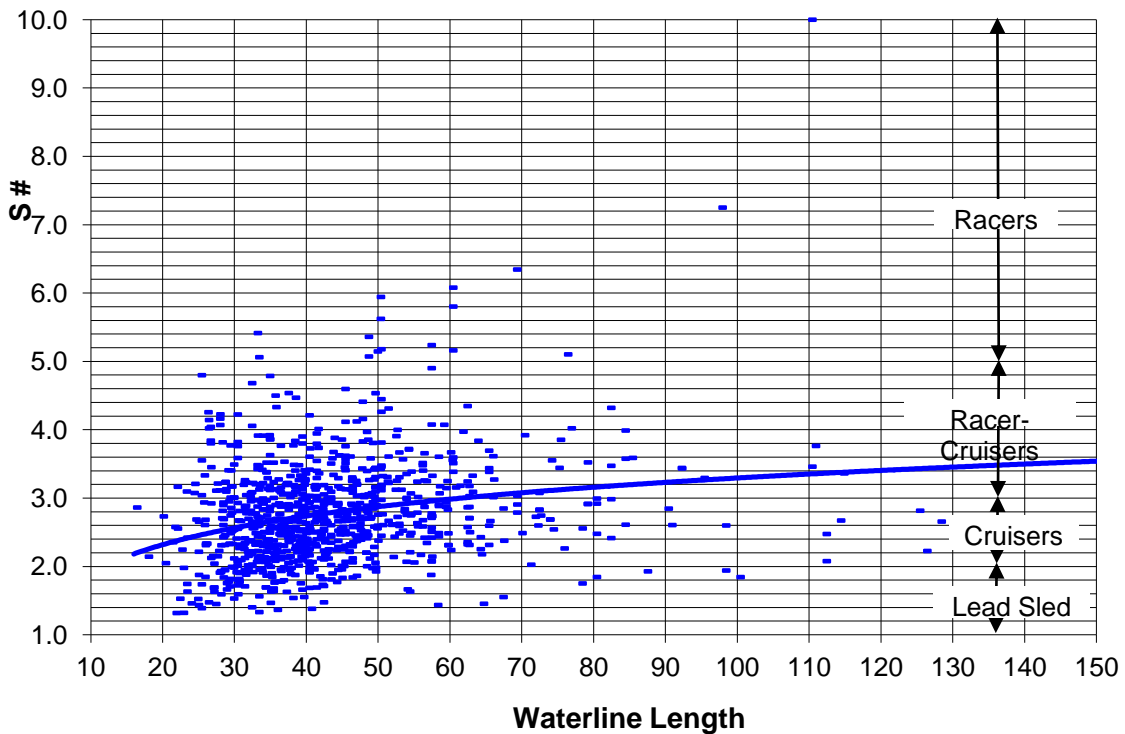

Note that the 2011 catamaran database contains many more boats than the original one displayed in other charts...990 in fact.

S Number vs. Base Speed Comparison

Since S# and Base Speed are both intended for comparative performance predictions, it is worth discussing whether one is better than the other. S# is just a number, whereas Base

Speed is an estimate of average speed over a 24 hour period under race conditions. So Base Speed feels better.

However, when S# is plotted against Base Speed, Fig. 11b, its significance becomes apparent as follows: whereas Base Speed indicates potential boat speed, it doesn't give any indication of the type of boat. S# gives both, but the speed potential is just a number between 1 and 10. So, the faster boats with lower S# are big, fast cruisers and racer cruisers (think Gunboat 90). The fast boats with very high S# are indeed racers. Thus, both indicators are valid and both should be used together in comparing one boat against another.

Fig. 11b - S# v. Base Speed

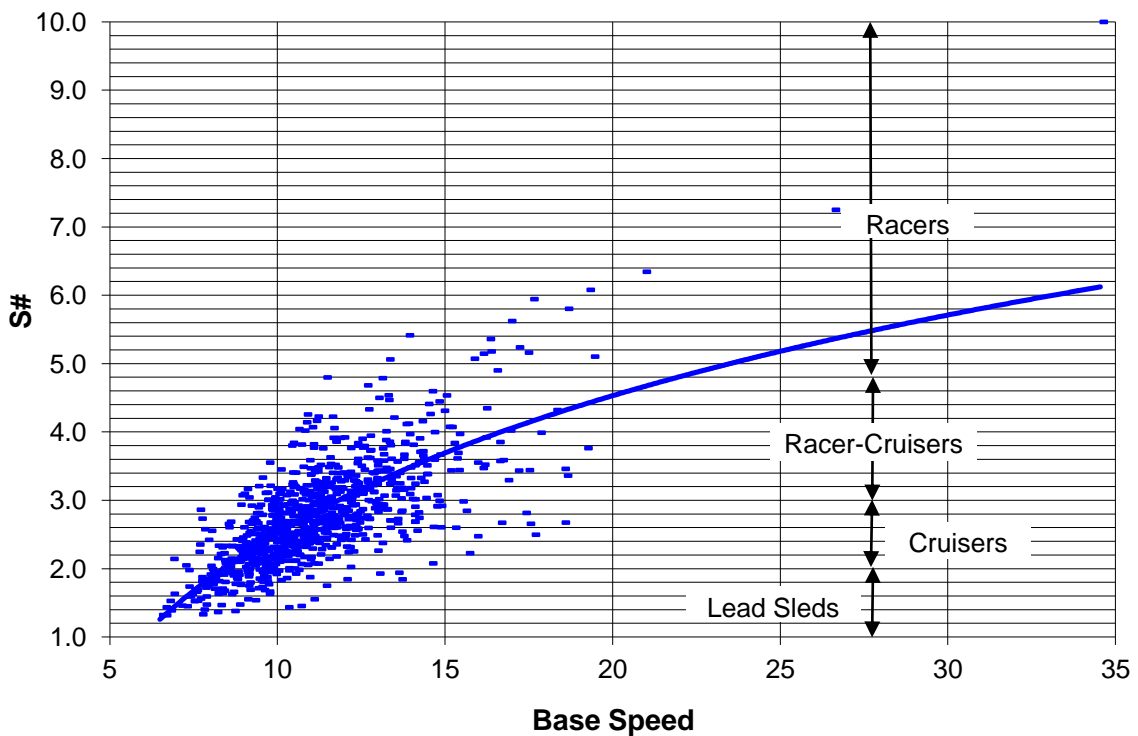

Texel Rating

Texel Rating, shown in Fig. 12, is a system which allows different multihulls to race against each other. This system is originally developed by Nico Boon for the biggest beach-type catamaran race in the world, the Ronde om Texel (the Texel Round) in The Netherlands. Later this system was extended to sea-going catamarans and trimarans.

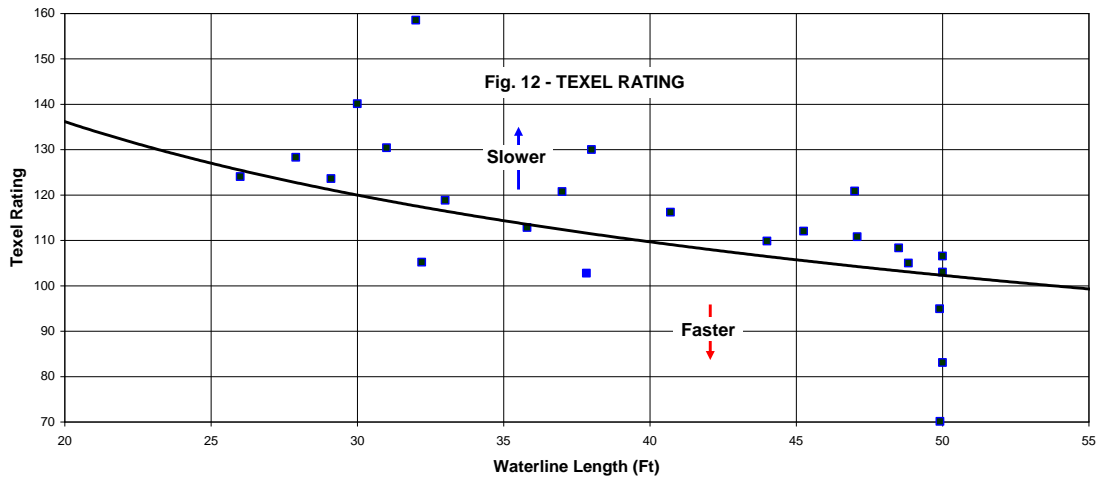

An excellent presentation on the Texel Rating may be found at the website www.texelrating.org. See especially the writing “Why Texel Rating” by Nico Boon on the Royal Dutch Yachting Union portion of this site for the background of this rating system.

Clicking the logo for the Dutch Catamaran and Trimaran Club shows the specifications needed and the formulas used for cruising multihulls. It can be seen that precise measurements of numerous hull and sail parameters, plus information on propellers and keels (fixed, centerboard, low-aspect ratio, etc.) can be taken into account for these calculations. There is an adjustment to catamarans to make them compare more fairly to trimarans. Nico Boon states that different countries (and possibly different clubs) either use or do not use these correction factors.

The form of the rating equation used for this article is a very basic one that gives an approximation of the actual rating. Considering the specification data used, i.e., data that is readily available in sailing magazines and websites, and considering that different readers may or may not be interested in applying the corrections, the basic equation is, $TR = 100 / (0.99 * (Lwl)^{0.3} * (SA)^{0.4} / (D)^{0.3} * K$ in which K is a correction for catamarans vs. trimarans, based on the equation, $K = 1 / (0.19 * SA^{0.4} / D^{0.36} + 0.91)$, if greater than 1 (otherwise 1) for cats, and $K = 1$ for tris. (Note: These equations require metric specification inputs.) This gives an approximation of the Texel Rating that is useful to compare one boat to another. It ignores corrections for keels, propellers and several sail and hull shape matters.

The catamaran correction K given above is approximately one percent for racing cats and from four to six percent for the cruising cats. Nico Boon explains “In 2000, Erik Lerouge in France started to introduce a correction for cats as well as trimarans. The maximum difference between the two was about 5.6 %. Very fast and light catamarans only were considered to be equal to trimarans with the same dimensions. Why? Cabin trimarans have less wetted surface, generally sail a bit better, hard on the wind, can tack faster than catamarans.”

Bridgedeck Clearance for Catamarans

2007 Evaluation

The following standards for Bridgedeck Clearance (BdCl) have been discovered through the literature and direct contacts with the sources:

Source	Standard
Jeff Schionning	Cruising Cats 24-30 inches (61-76 cm) Performance Cats 27-35 inches (69-89 cm) Racing cats 30-40 inches (76-102 cm)
Westlawn Institute of Marine Technology	The bridgedeck should be at least 30 inches above the waterline, or 80% of waterline beam overall, or 66% of WL length, whichever is higher. The higher the better. On small cats under 30 feet, use the 80% of WL beam OA, which would be lower than 30 inches.
Tony Grainger	6-7% of waterline length
Ian Farrier (F-41)	31 inches (79 cm)
The Multihull Source	2.5-4 feet (30-48 inches or 76-122 cm)
Sail Magazine	Greater than 2 feet (61 cm)
Sailnet.com	30 inches (76 cm)

There is a wide disparity in these values, reflecting a wide difference of opinion within the design community. The objective in establishing bridgedeck clearance is avoidance of pounding of waves against the underside of the bridgedeck, a phenomenon that can be both nerve-wracking and damaging to the boat structure.

Schionning indicates that the clearance should vary depending on use. The Westlawn standard suggests that beam is the driving element rather than length, and a narrower boat can get by with less clearance than a wider boat of the same waterline length.

For the purposes of evaluating this specification element on the Multihull Dynamics, Inc. website, the MINIMUM recommended clearance is defined as follows: Bridgedeck Clearance should be at least 6.25% of Lwl for boats up to 40 feet Lwl and 30 inches for boats greater than 40 feet Lwl.

Boat Waterline Length	MINIMUM Bridgedeck Clearance
Less than 40 feet	6.25% of waterline length*
Greater than 40 feet	30 inches

*It should be noted that 6.25% of 40 feet is 30 inches.

NOTE: Bridgedeck Clearance vs. Minimum Clearance is shown in the boat data on this site. This is shown as plus (+) or minus (-) results, i.e. the number of inches or

centimeters the Bridgedeck Clearance varies from the MINIMUM Clearance for catamarans of that waterline length. Plus (+) means more clearance than the minimum, minus (-) means less.

In cases where bridgedeck clearance varies in height above the waterline on a boat (i.e. forward clearance is higher than aft or vice versa), the lowest height is used for reference to bridgedeck clearance for a boat in the database.

2010 Re-evaluation

In the three years since the original search for a “standard” for bridgedeck clearance for catamaran sailboats, two significant things have happened: 1) bridgedeck clearance data for many more boats has been obtained and 2) the number cruising catamaran designs in the 50-75 foot range has increased dramatically. As a result, it is possible to establish a trendline using the capabilities of Excel. This represents the apparent practice by current designers in this regard. It can be noted in the graph below that as waterline length is increased, bridgedeck clearance is being increased linearly.

A graph of the 246 boats in the database for which we have this data with the current trendline and minimum recommended clearances is below. It is interesting that the trendline crosses through 30 inches at 40 feet Lwl.

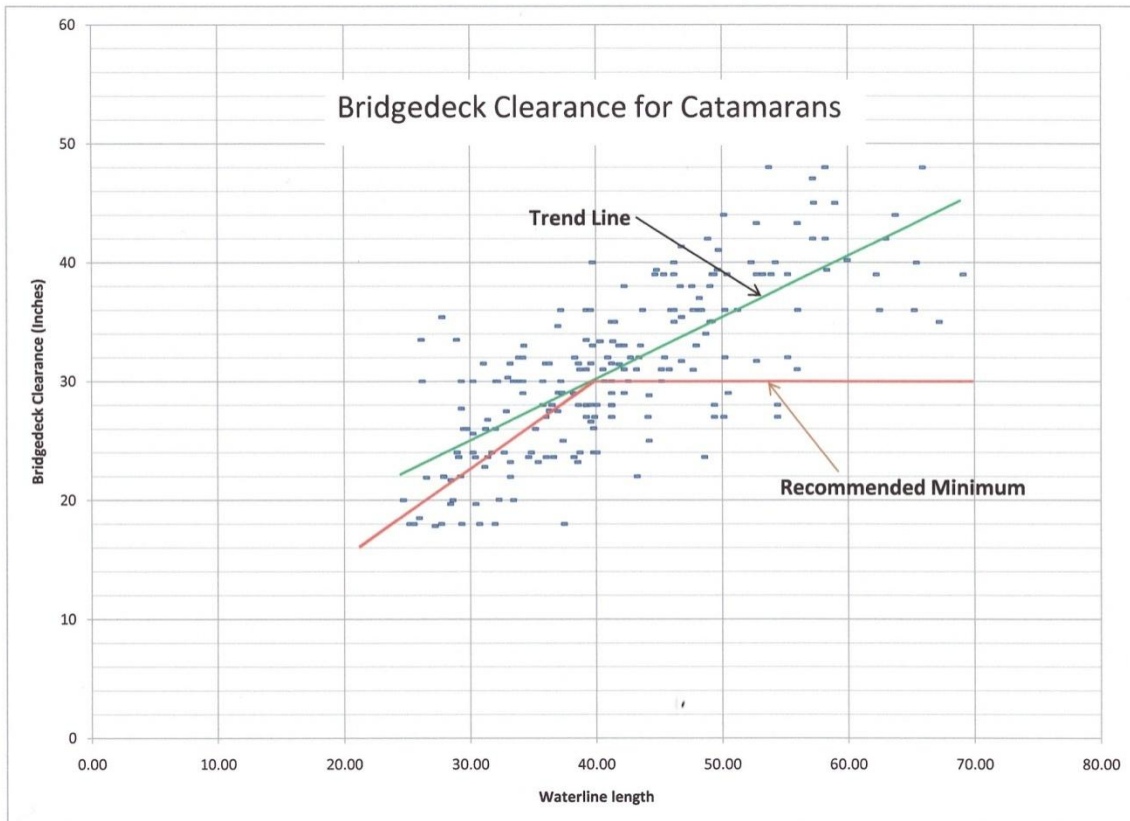

It can be noted that many of the boats in the database are below the recommended minimum line. You can read about the wave pounding results in books and articles about sailing these boats.

There is more involved, however, in wave pounding under the boat deck than just bridgedeck clearance. Three other items come to mind: 1) pitching characteristics of the boat, 2) distance of the bridgedeck from the bow (more is good) and 3) the fullness of the bows and hulls (slimmer is good). We do not have data or analysis for these factors, but the things to look for that minimize pitching are significantly different shapes of the forward half of the hulls from the aft half, and concentration of the weight of the boat and its payload in the center, not in the ends and aloft.

Builders of catamarans with the bridgedeck extending well forward between the hulls argue that they do not have slamming problems as long as the bridgedeck clearance is adequate, but it would be interesting to have some boat-to-boat comparisons.

Whether the waves that pound under a bridgedeck are 1) those the boat is sailing into or 2) those the boat forms while moving through the water is also not well defined. Some of the argument for a given bridgedeck clearance is based on bow waves interacting between the hulls and against the deck. To the extent that this is the case, slender bows and slender hulls that minimize bow wave formation will improve the wave pounding characteristics of the boat.

Stability

Stability Index

After all of the comparisons above, something is needed to tie displacement, beam and sail area for the one thing that stays in the mind of all prudent multihull sailors...capsizing. The ratio of the stabilizing moment of the boat (displacement multiplied by the half-beam or $D \cdot Bcl/2$) to the overturning moment (sail force times the height of the center of effort, H_{ce} , of the sail above the center of lateral resistance of the hulls and boards or keels) provides the **Stability Index**, a useful comparison factor. Since sail force is proportional to sail area, sail area is used in the calculations.

It is imperative to use the beam measured at the centerlines of the hulls for stability calculations. To use overall beam is both technically incorrect and misleading as some designers expand the hull above the waterline for living accommodations, e.g., John Shuttleworth. The derivation of this index is included as Appendix B.

Drawings of the sails show most extend about 90% of the boat length, but have a large roach on the main. A simplifying assumption for comparison purposes is that the sail plan is a triangle with a base the length of the boat and a height whatever is needed to provide the advertised sail area. (A detailed calculation would be more accurate, but it would take data which is not available in the sources used.) This allowed the mast heights to be approximated and, in turn the height of the center of effort, H_{ce} , calculated. See Appendix A for the derivation of H_{ce} .

The **Stability Index** equations that result are:

For boats with Lwl less than 40 feet	For boats with Lwl over 40 feet
$SI = D \cdot Bcl \cdot Lwl / SA(SA + 0.375 Lwl^2)$	$SI = D \cdot Bcl \cdot Lwl / SA(SA + 10Lwl)$

The results are shown on **Fig. 13 - Stability Index**. It supports intuition about how the various factors should affect capsize stability. There is a clear trend toward higher numbers as boat length increases. Sail area appears squared in the denominator of the equation for the Stability Index because as sail area increases, the height of the center of effort increases proportionately, so the result is not surprising.

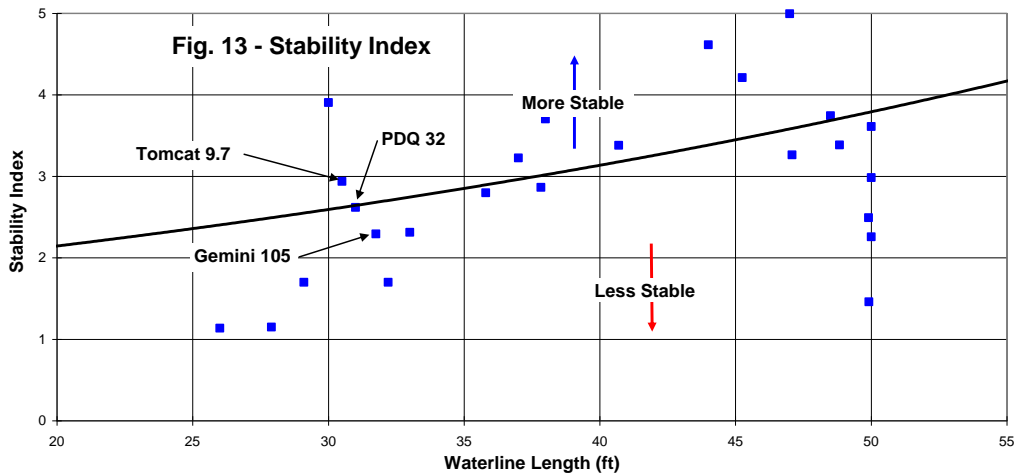

Boat designs on the lower boundary of the data tend to have lighter weight and larger sails...racing configuration. If they also have a wide beam, they should be reasonably safe and fast. On the other hand, light boats with large sails, light weight and modest beam should bear careful watching. A boat on the upper portion of the plot, with modest sails, large displacement and wide beam should be quite safe, but not as exciting. And so forth. "You pay your money and you take your choice."

Comparisons of some of the boats using Stability Index are interesting. The table below shows the figures for some of the smaller boats.

Boat	Length	Centerline Beam	Displacement	Sail Area	Stability Index
Tom Cat	32 ft.	12.79 ft.	3.18 tons	470 sq. ft.	2.79
PDQ32	31.6 ft.	12.81 ft.	3.2 tons	443 sq. ft.	2.62
Gemini 105M	33.5 ft.	13.39 ft.	3.26 tons	510 sq. ft.	2.29

The Gemini 105M will have more of a tendency to lift a hull than the other two, with PDQ32 being the least likely. The displacements are nearly identical and Gemini 105M is

nearly half a foot wider than the others, but the effect of sail area appears to be a driver in this calculation. These results are borne out by the following stability calculation as well.

Stability Speed

John Shuttleworth offers a formula for the wind speed in knots at which hull lifting will occur, $SF = 9.48 * ((0.5 * Bcl * D) / (SA * Hce))^{0.5}$. It includes a 40% gust factor. It appears as “*Stability in Wind*” in his design booklet.⁶ For the analysis in this article, Hce is approximated in the same fashion as for the Stability Index, with the derivation contained in Appendix A. Shuttleworth did not provide a name for SF, so I have labeled it **Stability Speed** on Fig. 14. At best, it is an approximation, suitable for comparisons rather than the absolute hull lifting speed.

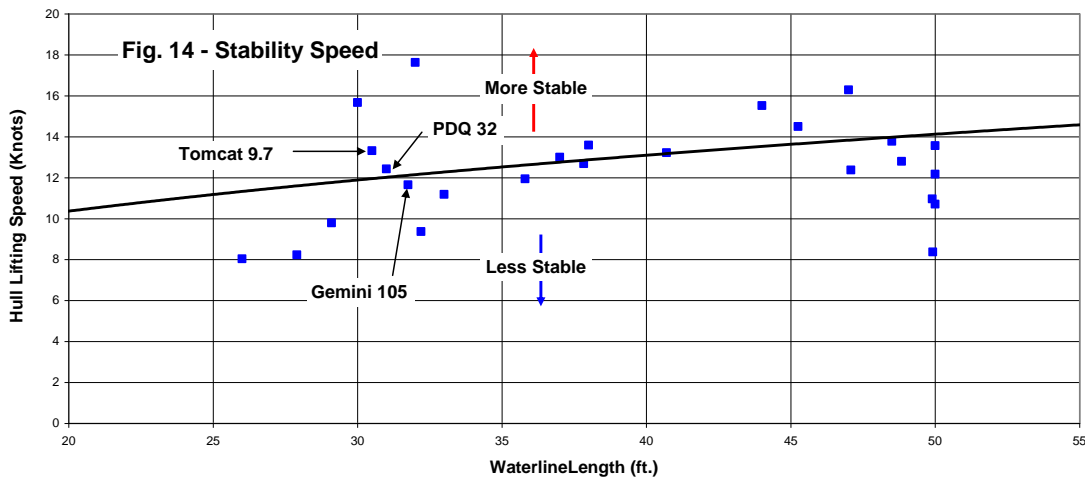

For the small cruisers discussed above, Gemini 105M has a Stability Wind Speed of 11.64 knots, while Tom Cat has 13.31 knots and PDQ32 has 14.02.

Shuttleworth says “Typical values for SF can vary between 12 mph (10.42 knots) for a Formula 40 racing catamaran, to over 40 mph (34.8 knots) for cruising multihulls. Modern light cruiser-racers would be in the range of 24-30mph (21-26 knots).”

Comparisons of Stability Speed of some of the larger boats can be made from the table below.

Boat	Length	Displacement	Sail Area	Stability Speed
Double Bullet	76 ft.	17 tons (light)	4200 sq. ft. (large)	9.22 knots
Lagoon 82	81.7 ft.	40 tons (heavy)	2691 sq. ft. (small)	21.95 knots
Atoll 25	81.7 ft.	25 tons (medium)	2368 sq. ft. (small)	17.94 knots
Ocean Voyager	82 ft.	22.6 tons (medium)	2712 sq. ft. (small)	16.87 knots
Magic Cat	82 ft.	25 tons (medium)	4200 sq. ft. (large)	11.51 knots
MaxiCat 25	85.3	50 tons (heavy)	4306 sq. ft. (large)	19.18 mph

⁶ “Multihull Designs” by John Shuttleworth Yacht Designs Ltd., 1998, p. 37.

Double Bullet is a light, powerful racer. Magic Cat appears to be a racing-cruiser, more given to racing than cruising. The others are cruisers ranging from medium to heavy, with conservative sail areas.

Cruising Trimarans

Introduction to Trimarans

There is specification data for far fewer trimarans than catamarans in the sources used for this analysis. Sailing magazines are full of pictures of trimarans, but three factors seem to be at work to limit the data: 1) many of the trimarans featured are one-of-a-kind racing boats about which specifications are very difficult to find, 2) many of the specification sheets are missing displacement or sail area or both, and 3) many of the boats for which data is available are the same boats! For example, Ian Farrier's designs appear in numerous manufacturers web sites and their boats appear in many racing events, but they represent only six or seven unique designs, with many small variations. Thus the data base is significantly smaller for trimarans than for catamarans. However, there is enough variety to make the analysis worthwhile. The charts in this section represent the complete data base.

The most serious challenge to comparative analysis of trimarans is the large variety of choices in design of the outriggers. Several examples will illustrate this variety.

Outriggers immersed while boat is at rest, or not

During the 1960s, in AYRS publications, there was considerable controversy over whether the outriggers should be immersed at rest, always providing part of the displacement, or not. Recent designs seem to have put this to bed for the most part, with the outriggers generally above the water or just barely touching. This means that the main hull accounts for the displacement of the boat, at least in a static condition. Dick Newick's trimarans might be an exception, because the main hull waterline beams are generally less than computed by the approximating formula used in the analyzing the boats, suggesting that some static displacement is credited to the outriggers.

Large outriggers vs. small outriggers

Again, in the early days, some trimarans had outriggers that displaced less than the weight of the boat, crew and payload and thus could fully immerse when the wind heeled the boat. This was considered by some designers to be a plus, because the wind would spill out of the sail and prevent capsize. Other outriggers could displace from the full weight of the boat, crew and payload to several times that amount. Recent designs appear to be of the latter choice, with the boats indeed capable of sailing on an outrigger alone when in strong wind conditions. However, the outriggers lengths vary from about 70% to 100% of the main hull length.

Outriggers placed forward vs. centered

Some trimarans have the outrigger bows at or ahead of the bow of the main hull. Others have the outriggers somewhat centered. Others are everywhere in between.

Outrigger displacement positioning

A lot can be done with stability of a trimaran by moving the displacement of the outriggers foreword or aft. John Shuttleworth (inadvertently?) gave a lot of insight into this in his article "Beyond the Tektron 50...the design of the new Dogstar 50" in the March/April 2002 issue of *Multihulls Magazine*. He was writing about catamaran design,

but he made a comparison with trimarans as follows: "...The trimaran still has the advantage in waves because the outrigger can be used to dampen pitching better than can be achieved in a catamaran. On a trimaran the outrigger's center of buoyancy can be in any position when the boat is at rest, but in a catamaran the center of buoyancy has to be exactly under the center of gravity of each hull. This limits the amount of movement in the center of buoyancy as a catamaran heels and hence the pitch damping that can be achieved...." As with other outrigger features, drawings and pictures of trimarans show nearly all possible choices in this are being used.

Outrigger shape

Some outriggers have clearly displacement forms. Others are designed for planing, some rather bizarrely so. Some have extreme rocker, others are flat. Some are canted outwards at the bottom, others parallel to the main hull. Etc.

For these reasons, as well as for lack of data on these details, this analysis of trimarans simply ignores the outriggers except for their contribution to lateral stability. And even this requires the assumption that each outrigger is capable of carrying the full weight of the loaded boat and is indeed the pivot point for a sidewise capsize if that occurs.

Analysis

It is essential to restate here, as with catamarans, that the analysis and discussions that follow pertain to hulls operating in a displacement mode, not in a planing mode as some trimarans are clearly capable of doing.

All of the analysis factors considered for catamarans apply well here, with the exception of the calculation of displacement-length. Each analysis factor is discussed below.

Overall Beam and Beam vs. Length

The trimarans in the data base are very wide boats! **Fig. 15 – Overall Beam/Length Ratio** shows this quite well. A comparison the trend lines of 40 foot boats shows a Boa/Loa ratio of 0.75 for trimarans and 0.54 for catamarans.

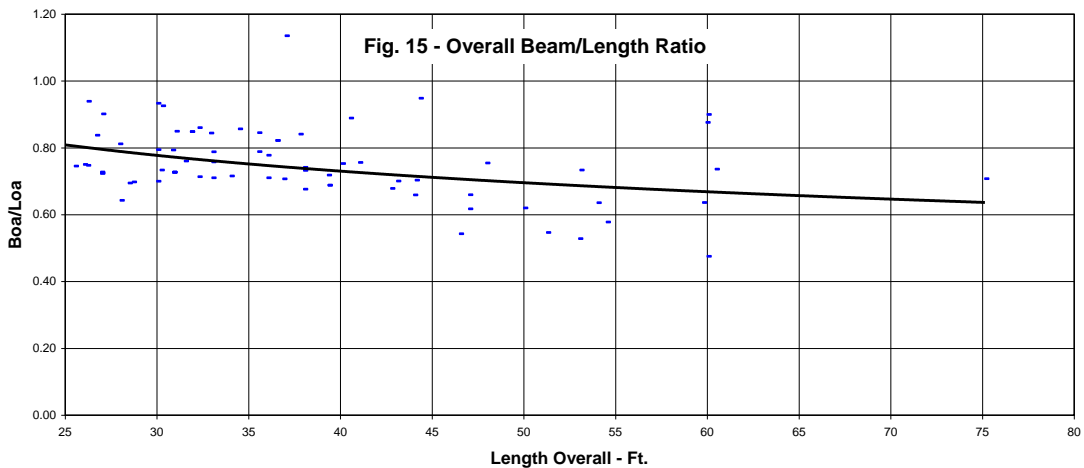

Trimarans tend to need space at a mooring or at the end of the dock because of this feature. However, Farrier's boats and a few of the boats of other designers have the ability to stow the outriggers against the main hull, making them more suited to normal slip size.

Hull Beam and Hull Length to Beam Ratio

For a catamaran, half the displacement is credited to each hull, while for trimarans, the entire displacement is credited to the main hull. Thus trimaran main hulls tend to have greater hull beam, **Bh**, and lower hull length to beam ratio, **Lwl/Bh**, than catamarans of the same waterline length and displacement. The formula for hull beam for the trimaran main hull is $Bh = 15.2 * (D/Lwl)^{0.5}$.

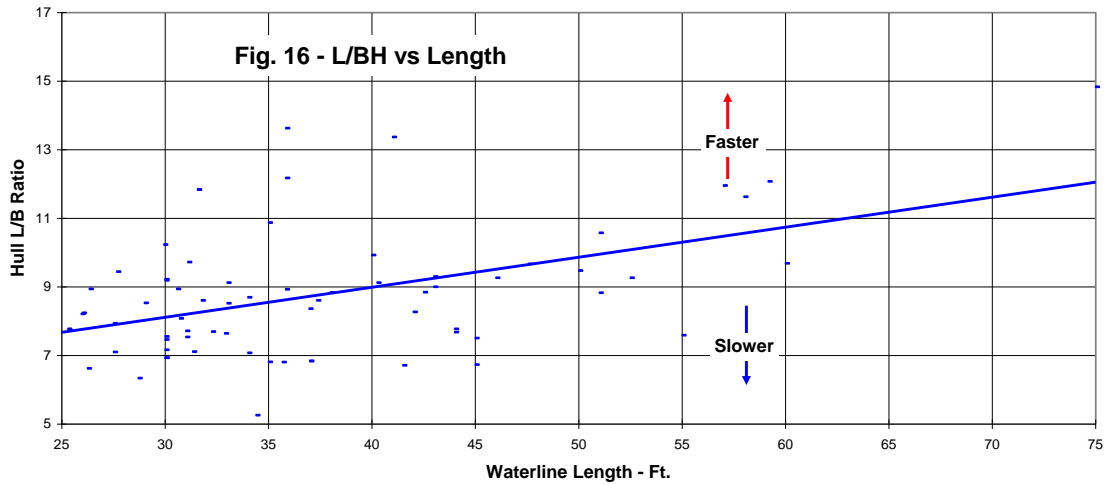

Most of the trimarans evaluated have Lwl/Bh ratios above seven as shown in **Fig. 16 - L/BH vs. Length**. Thus, hull speed drag rise should not be a problem for them. A few are below seven, primarily the Dragonfly boat family (displacement data was from their web site) and some of the Farrier boats.

With trimarans, the outrigger contributes one wave and the main hull contributes another, so wave interference between them will depend on their spacing and configurations.

Beam at Hull Centerlines and Bcl vs. Waterline Length

Centerlines for the outriggers was another data black hole. So an assumption was made that the distance between outrigger centerlines was 95% of overall beam. A check against a few drawings with enough size and clarity showed that this is a close assumption.

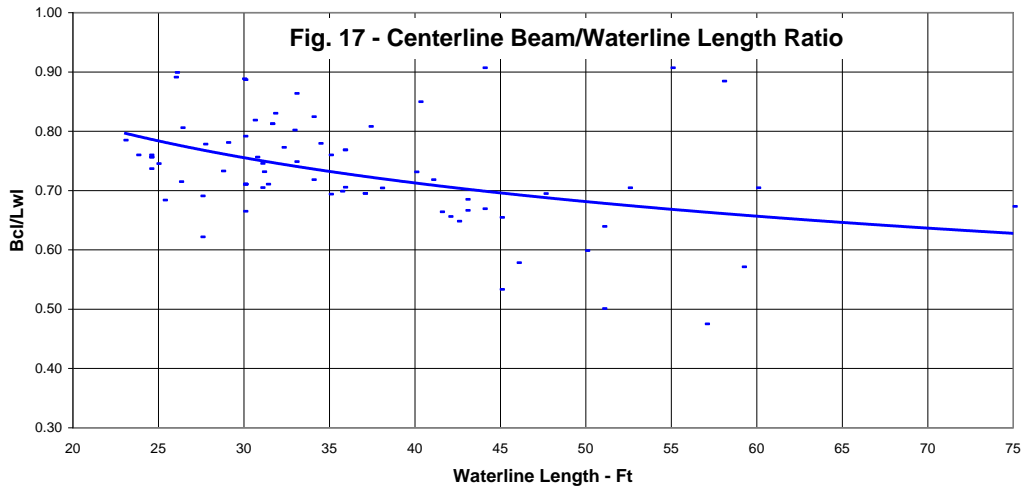

Another comparison of trend-lines showed Bcl/Lwl to be 0.78 for 40 foot trimarans and 0.47 for 40 foot catamarans. It is important to note, however, that when sailing, a trimaran is really a catamaran consisting of the main hull and one outrigger. Only a few of the really heavy, older trimarans actually sail on all three hulls.

Displacement vs. Length

Figure 18 shows the relationship of displacement to waterline length, with guide lines showing the corresponding waterline length to beam ratio of the main hull.

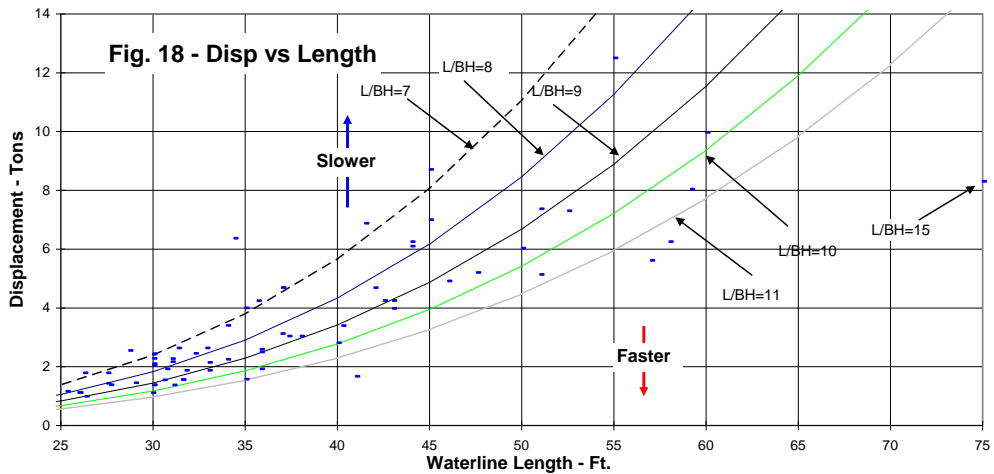

Displacement-Length Ratio

As noted in the catamaran analysis discussion, one formula that needs to be changed for trimarans is for displacement-length. For a catamaran, the displacement is shared by the two hulls, so the formula for a monohull, $(D \cdot (0.01 \cdot Lwl))^3$ was changed to $(D/2 \cdot (0.01 \cdot Lwl))^3$. For trimarans, however, the monohull formula is applied to the main hull. Values appear in **Fig. 19 – Disp-Length vs. Length**.

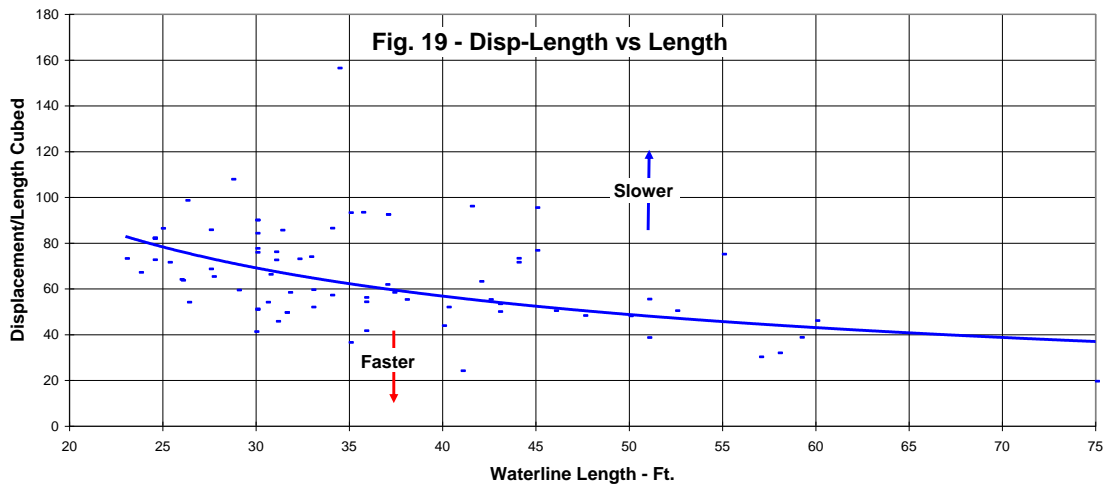

Sail Area vs. Displacement and the Sail Area/Displacement Ratio

There is an apparent spread of 40% or so in sail area for a given boat size as designers choose how much power to provide their boats and work the balance between speed and stability, or performance and safety. The results show up, of course, in the performance and stability measures discussed later. A racer will be on the high side in these comparisons; a cruiser, especially if intended for charter, will be on the low side. In Fig. 20, the SA/D ratio is shown.

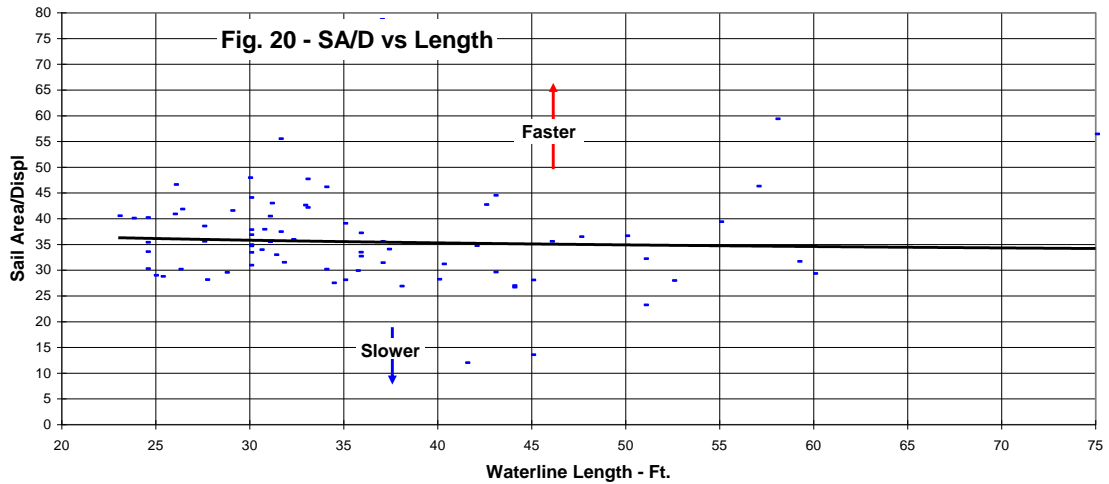

Performance

Performance Index, Base SpeedTM, Texel Rating and Bruce Number

These indices of performance are all calculated by the same formulas as for catamarans except for the Texel Rating for which trimarans do not get the catamaran correction K. The charts show the results.

The **Performance Index** and **Base Speed** charts, Figures 21 and 22 respectively, show the boats closely grouped around the trend line except for three fast boats and two slow ones. The fast boats are the 60 foot Lakota Tri , 41 foot Alinghi and 37 foot Scat. Lakota and Alinghi are spectacular racing boats and Scat is an experimental hydrofoil boat. Several of Newick's boats also have performance in the racing category. All display light weight and large sail area.

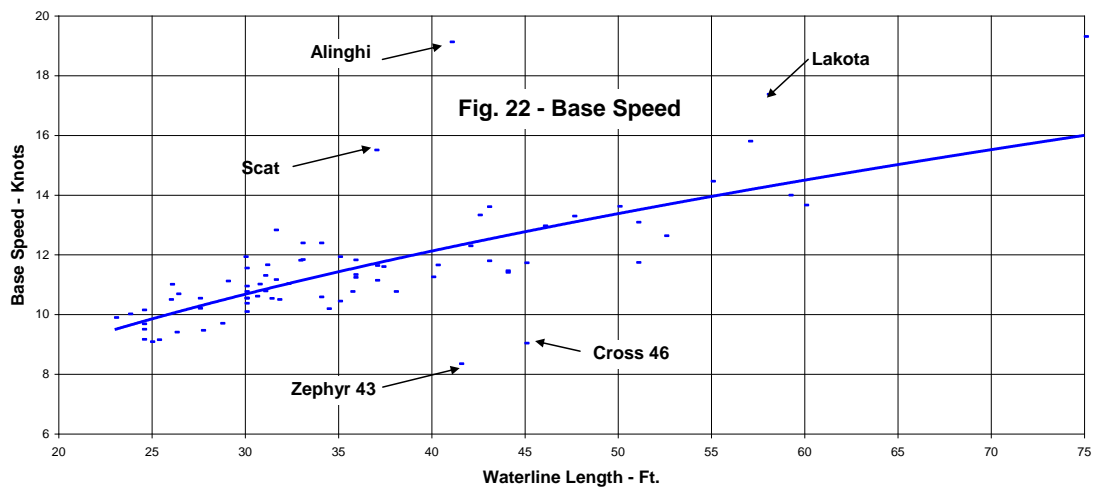
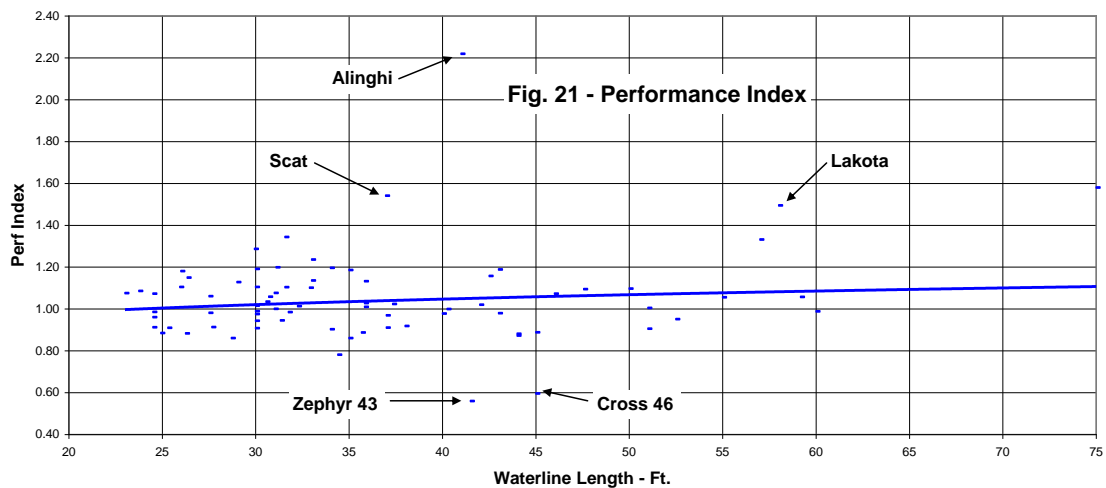

The slow boats are the 46 foot Cross and the 43 foot Zephyr. The Cross is relatively heavy and underpowered while the Zephyr 43 is a wide, moderately heavy boat carrying

a rigid wing-sail of very small area (465 square feet compared to over 1000 for most trimarans its size).

As discussed in the Catamaran section, **Texel Rating**, shown in Figure 23, is a handicapping system used in various forms in various countries. The values shown in the figure are an approximation of those used, with no corrections made for specific sail, keel nor propeller configurations.

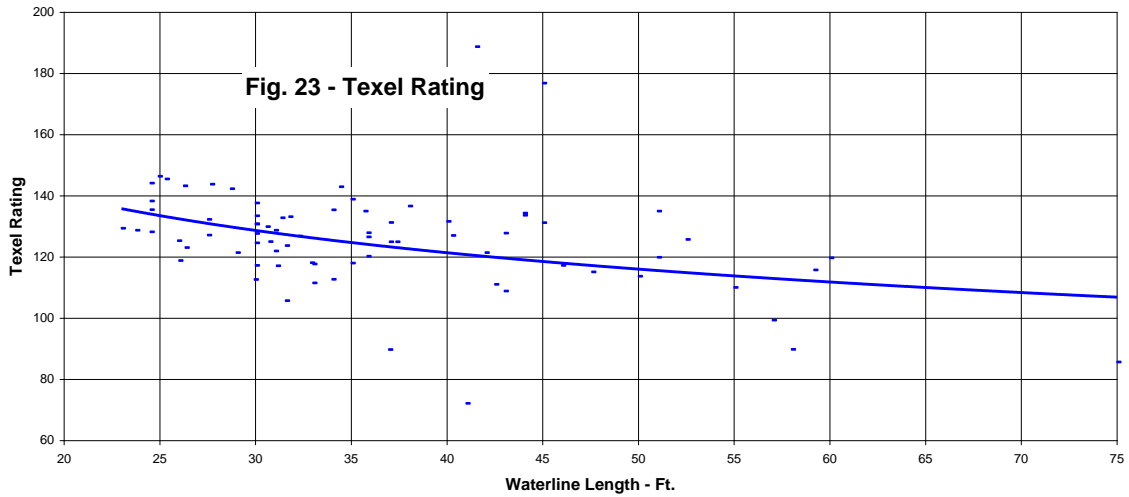

The **Bruce Number** chart, figure 24, shows that about two-thirds of the trimarans featured are modestly rigged and about one-third performance rigged. The two slow boats mentioned above are low, as expected.

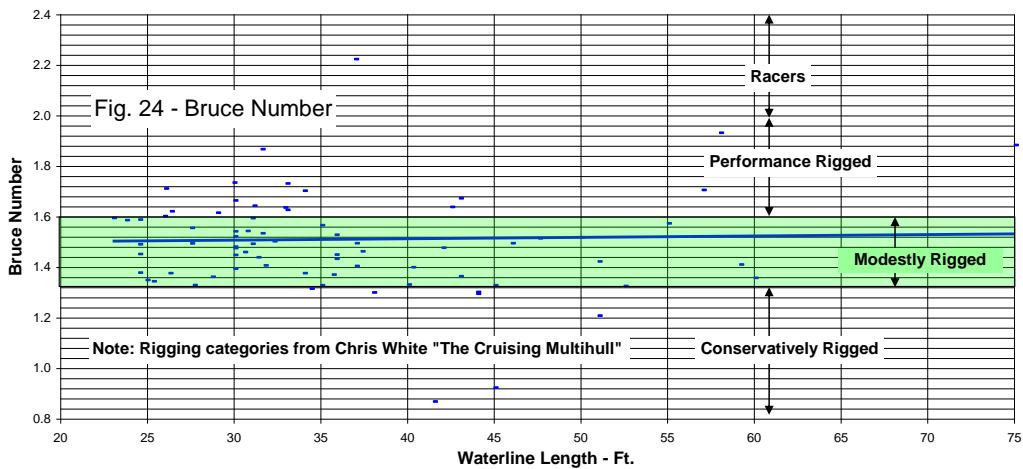

Stability

Stability Index and Stability Speed

The **Stability Index** and **Stability Speed** charts, figures 25 and 26 respectively, show three very low stability boats and one very high. The low stability boats are Lakota, Alinghi and Scat, showing that low capsizes stability goes along with light weight and large sail area for racers. The very high stability boat is the Zephyr 43, discussed above.

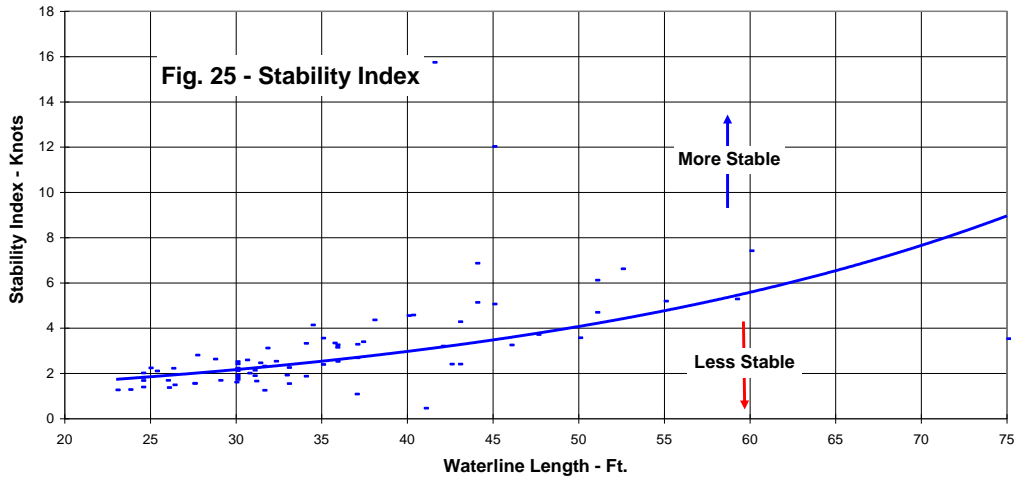

Note, however, that for a trimaran, Stability Speed is the wind speed at which the main hulls lifts from the water and the boat is sailing on the leeward outrigger.



Catamarans vs. Trimarans

Having analyzed catamarans and trimarans, it is irresistible not to compare them. The trend line values for 40 foot boats from each category are compared in the table below.

Element	40-Foot Trimaran Trend Value	40-Foot Catamaran Trend Value
Displacement	4 tons	6 tons
Sail Area	900 sq. ft.	920 sq. ft.
Sail Area/Displacement Ratio	35	26.5
Performance Index	1.04	0.83
Bruce Number	1.5	1.29
Base Speed	12 knots	10.8 knots
Texel Rating	95	109
Stability Index	3	3.2
Stability Wind Speed	13	13

The meaning of these numbers probably could be debated for decades, and would even be a good topic for discussion by multihull designers at a designers' forum.

One possibility is that the combination of main hull, two smaller outriggers and open space between them in a trimaran is lighter than two hulls and a connecting wing deck typical of a catamaran results in the lower weight of the tri. With nearly the same sail area, the trimaran sail area/displacement ratio, the power-to-weight equivalent, is significantly higher.

Another is that the comparatively greater beam of the trimaran allows these lighter boats to have equivalent stability to the heavier catamarans.

Another possibility is that many of the catamarans in the 35-50 foot range are specifically designed for chartering. They tend to be heavy to provide all the required living amenities and are typically equipped with modest sail plans. A scan of the Lwl/Bh and SA/D columns in the catamaran data base behind the charts shows that Lagoon and Privilege families of boats are typical of these characteristics. This class of boats tends to depress the values of the performance indices while supporting the stability indices.

Other views are welcomed!

Limitations and Missing Items

As stated at the beginning of this writing, the formulas and calculations are first-order ones. If two boats have the same displacement, overall length, waterline length, beam and sail area, they would have exactly the same results. In reality, the boats might be significantly different depending on the actual hull shape above and below the waterline, keel or daggerboard and rudder design, rigging configuration, cockpit enclosure, etc. For example, John Shuttleworth describes the redesign of the his Tektron 50 into the Dogstar 50 in *Multihulls Magazine*, pp. 49-55, March/April 2002 issue. The resulting numbers show a three percent increase in Base Speed by the analysis included here, which can only consider a 12 percent weight reduction. Shuttleworth, however, estimates a 12 percent increase in reaching speed, resulting from a combination of weight reduction, hull wind drag reduction, structural refinements and significant changes in the sail plan.

What's missing? Well, the data, and thus this study, contained nothing about the true underwater configuration of the boats. Whether they have high or low aspect rudders and keels would make some differences. What appears in drawings and pictures is that Catana boats and a few others have high aspect ratio dagger boards and the majority have low aspect ratio keels, probably because they are optimized for cruising, and that in a charter mode. However, there seems to be a growing trend toward the dagger boards in the 2000s. And as stated in the trimaran analysis, details of the outriggers are not included.

At the time of the writing of the AYRS book, Bruce and others were debating whether high or low aspect ratio keels were better, with mixed conclusions. Bruce had shown analytically and experimentally that canted keels or boards ("Bruce Foils") could be used to offset the heeling moment produced by the sails. In fact he showed that if the line of force perpendicular to the keels or boards passed through the centroid of the sail, the boat would be non-heeling. You can see a little of this in some designs, particularly in trimarans with the boards in the amas (outriggers).

Potential Future Developments

Actual performance data of various boats for comparison would be an exciting thing to have. However, obtaining it has apparently been very difficult except for race results. Race results by themselves contain many arbitrary factors, such as crew skill, boat preparation, wind and water conditions, breakdowns, etc. Richard Boehmer used actual race data to develop his Base Speed™ formula, but even that remains less satisfying than measured performance against established wind criteria would be.

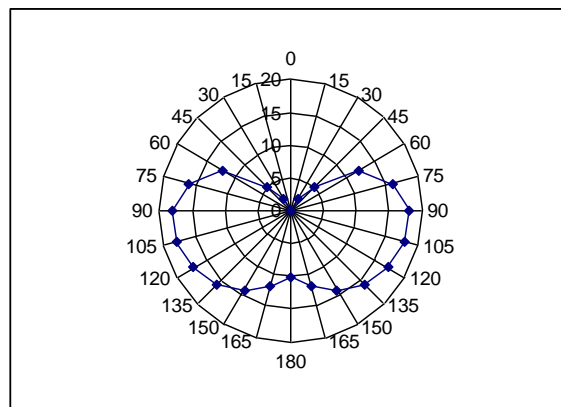

The late Edmond Bruce in the AYRS book showed a product called a “performance polar” where, for a given wind speed, a boat’s speed would be measured over courses at various angles to the wind and the results plotted on a polar diagram as shown. A few of these appear from time to time in the literature, but not consistently.

This kind of data could be gathered if a party or club owned a good quality wind speed and direction indicator and a Global Positioning System device. The wind instruments should be placed on a fixed location (anchored boat, for example). The GPS device should be carried on the boat being evaluated to measure boat speed and course direction. Data could be recorded for multiple data points and a family of polar plots developed, e.g., one plot for each wind speed block of 5, 10, 15 and 20 knots. If there were enough interest, perhaps a boat club or multihulls magazine publisher could be persuaded to collect and correlate all of the data.

Conclusion

And what does the reader do with this information? The relative performance potential of the various boats can be inferred from the data and graphs included here. This is of vital interest to a person selecting a boat. Designers can use the data to obtain design points for their boats. Modelers might build competing scale model boats to evaluate variations. For some, it is simply of academic interest.

Calvin H. Markwood

e-mail: multihull.analysis@comcast.net

Appendix A: Sail Center of Effort Derivation

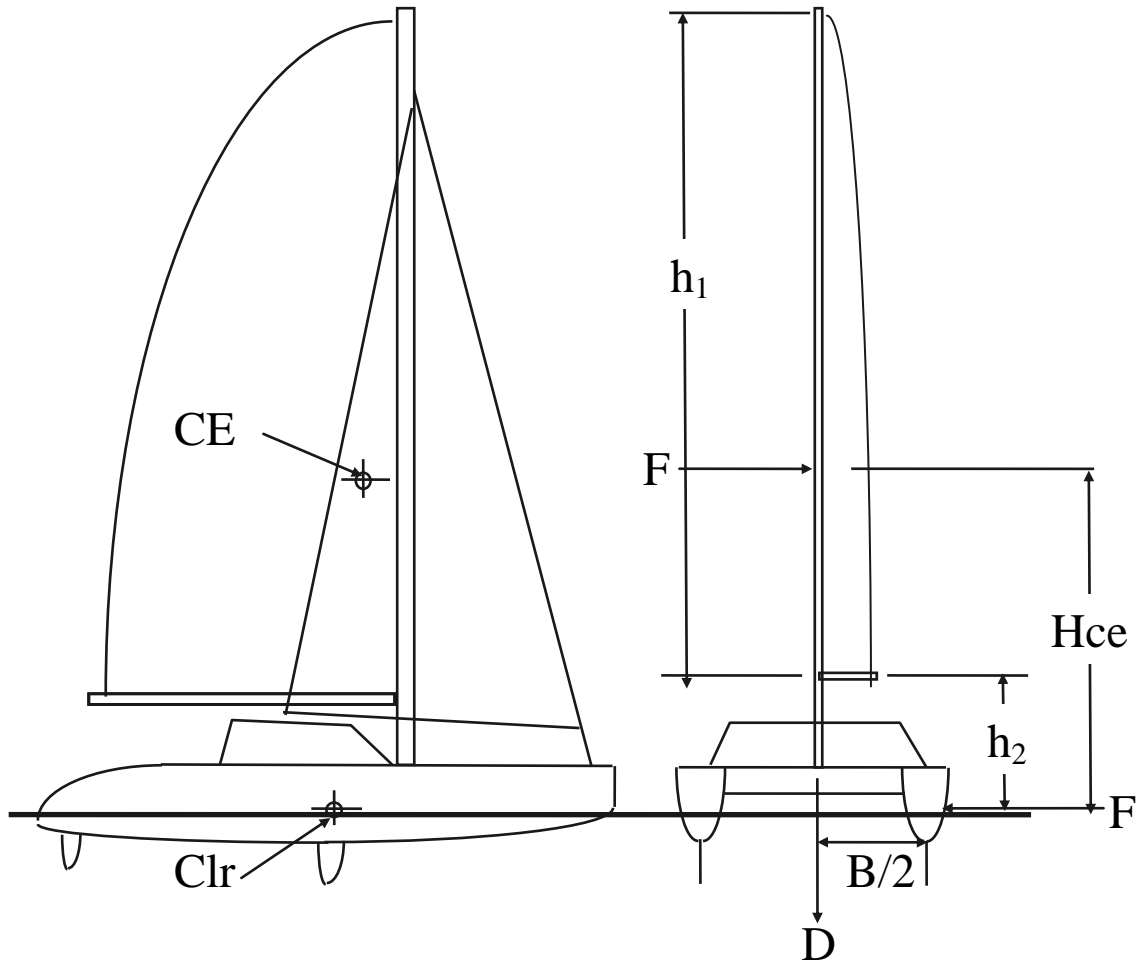

Derivation of Sail Center of Effort, Hce

To use the “Stability in Wind” formula from Multihull Designs by John Shuttleworth Yacht Designs Ltd., 1998, p. 37, it is necessary to have the height of the lateral center of effort of the sails above the center of lateral resistance of the hulls and boards or keels. That data is not readily available in the magazines from which the data for this writing are taken, so an approximation is required. The derivation of Stability Index in Appendix B includes this and is repeated here for easy reference.

Assumptions: Assumptions from Appendix B that pertain to this topic are:

1. Sail area is assumed to be a triangle the length of the boat for the purpose of calculating the height of the sail. This is used in determining Hce for the diagram. In truth, most catamaran sails rigs appear to cover about 90% of the length of the boat and have a roach that ranges from modest to large. True lateral center of effort data would be nice to have but was not available for all boats.

2. The distance (Hce) is calculated as 1/3 the sail height, h_1 , (centroid of the sail triangle) plus h_2 , an assumption of the distance from the bottom of the sail to the center of lateral resistance of the hulls and boards. This assumption is 25% of the boat waterline length up to 40 feet, and a fixed 10 feet for the larger boats. This accounts for hulls and cabins with headroom plus boom clearance.

Resulting Equations:

Assuming Sail Area is a Triangle with base L and height H,

$$h_1 = 2 \frac{SA}{Lwl} \tag{1}$$

The distance from base of the sail area down to the hull/board center of resistance is

For boats up to 40 feet long	For boats greater than 40 feet long	(2)
$h_2 = 0.25Lwl$	$h_2 = 10$	

Hce is

For boats up to 40 feet long	For boats greater than 40 feet long	(3)
$Hce = (2/3)*(SA/Lwl) + 0.25*Lwl$	$Hce = (2/3)*(SA/Lwl) + 10$	

Appendix B: Stability Index Derivation

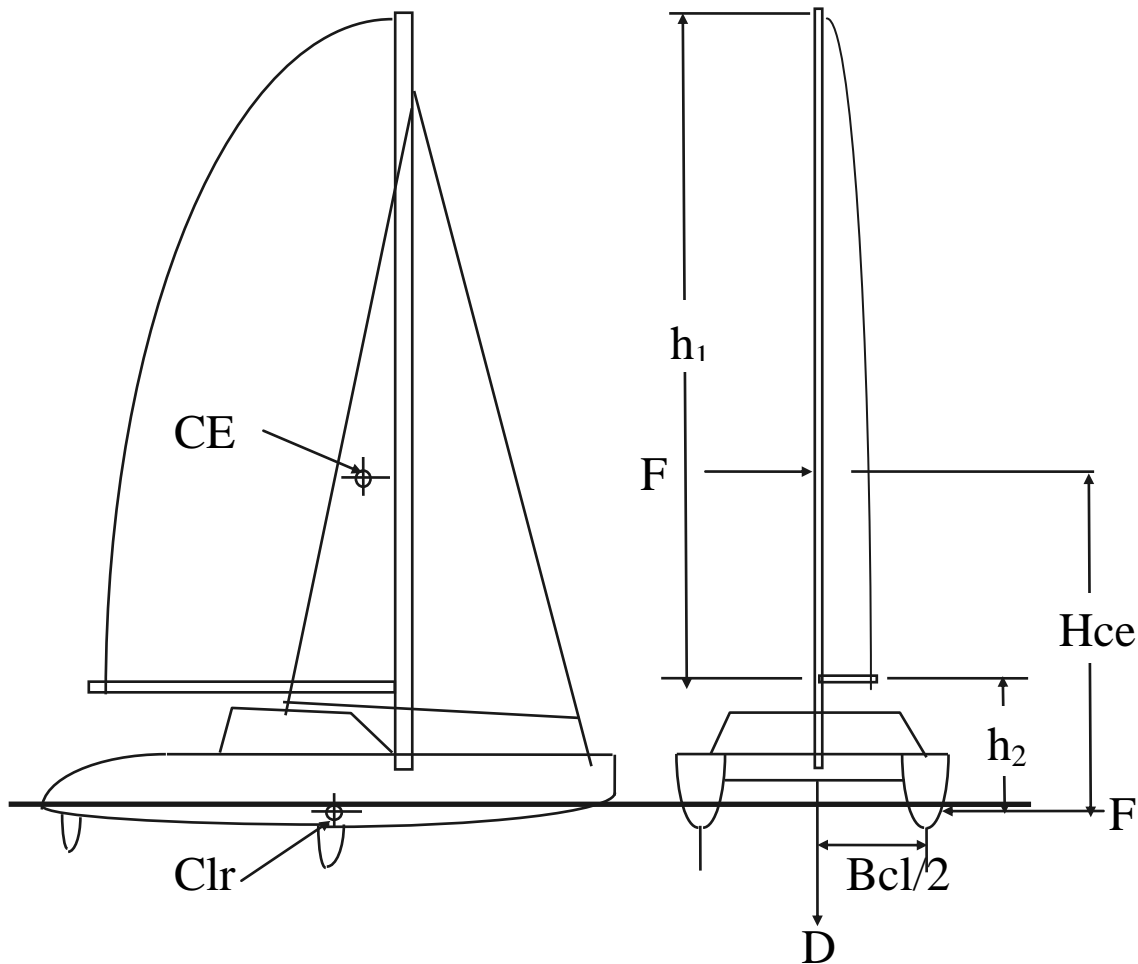

Derivation of Stability Index:

The **Capsize Moment** is the product of the sail force (F) and the distance H_{ce} between the center of effort of the sail, CE , and the center of lateral resistance of the hulls and boards or keels, Clr , as shown in the diagram.

The **Stabilizing Moment** is the product of the boat weight or displacement (D) and half of the hull centerline beam. For trimarans, this is half outrigger centerline beam.

The **Stability Index** is the Stabilizing Moment divided by the Capsize Moment.

Assumptions: Several assumptions are necessary to compute this index from the data in the cover article. They are:

1. The half-beam measured at the hull centerline can be used in the stabilizing moment calculation. In truth, each hull configuration will be a little different, depending on width of each hull and symmetry or asymmetry of the hulls. For example, the late Lock Crowther canted out the bottoms of the hulls on the Catana designs, giving it more stability for the same beam than would a design that did not do this.

2. The sail arrangement is assumed to be a triangle the length of the boat for the purpose of calculating the height of the sail. This is used in determining Hce for the diagram. In truth, most catamaran sails rigs appear to cover about 90% of the length of the boat and have a roach that ranges from modest to large. True center of effort data would be nice to have but was not available for all boats. This approach understates the stability of boats with more than one mast, gaff rigs, etc.
3. The sail force is proportional to sail area.
4. The distance Hce was derived in Appendix A as 1/3 the sail height h_1 (to the centroid of the sail triangle). The distance from the bottom of the sail to the center of lateral resistance of the hulls and boards, h_2 , was assumed to be 25% of the boat length up to 40 feet, and then fixed at 10 feet for the larger boats. This accounts for hulls and cabins with headroom plus boom clearance.
5. When the calculations are done, constants are grouped and scaled up to give a result that plots well. The absolute values of the numbers are not important. The relative values for boats of similar sizes are indications of the ability of the boats to resist lateral capsize, considering weight, beam and sail area.

Resulting Equations:

Turnover Moment:

$$M_{TO} = FH \tag{1}$$

$$M_{TO} = F \left(\frac{h_1}{3} + h_2 \right) \tag{2}$$

Assuming Sail Area is a Triangle with base L and height h_1 ,

$$h_1 = 2 \frac{SA}{Lwl} \tag{3}$$

The distance from base of the sail area down to the hull/board center of lateral resistance is

For boats up to 40 feet long	For boats greater than 40 feet long	(4)
$h_2 = 0.25Lwl$	$h_2 = 10$	

Sail force F is proportional to SA, or, with k_1 the proportionality constant,

$$F = k_1 SA$$

Substituting into equation (2) and simplifying gives:

For boats up to 40 feet long	For boats greater than 40 feet long	(5)
$M_{TO} = k_1 SA \left(\frac{2SA}{3Lwl} + 0.25Lwl \right)$	$M_{TO} = k_1 SA \left(\frac{2SA}{3Lwl} + 10 \right)$	

$M_{TO} = k_2 \frac{SA}{Lwl} (SA + 0.375Lwl^2)$	$M_{TO} = k_2 \frac{SA}{Lwl} (SA + 15Lwl)$	(6)
---	--	-----

Stabilizing Moment:

$$M_{ST} = \frac{DB}{2} \tag{7}$$

The **Stability Factor** is thus:

For boats up to 40 feet long	For boats greater than 40 feet long
$\frac{M_{ST}}{M_{TO}} = k_3 \frac{D * Bcl * Lwl}{SA(SA + 0.375Lwl^2)}$	$\frac{M_{ST}}{M_{TO}} = k_3 \frac{D * Bcl * Lwl}{SA(SA + 15Lwl)}$

$k_3 = 1000$ in the analysis, chosen arbitrarily to plot well.

NOTE: These equations are valid for catamarans and trimarans.

Appendix C: Graphs for Database of 475 Cruising and Racing Catamarans

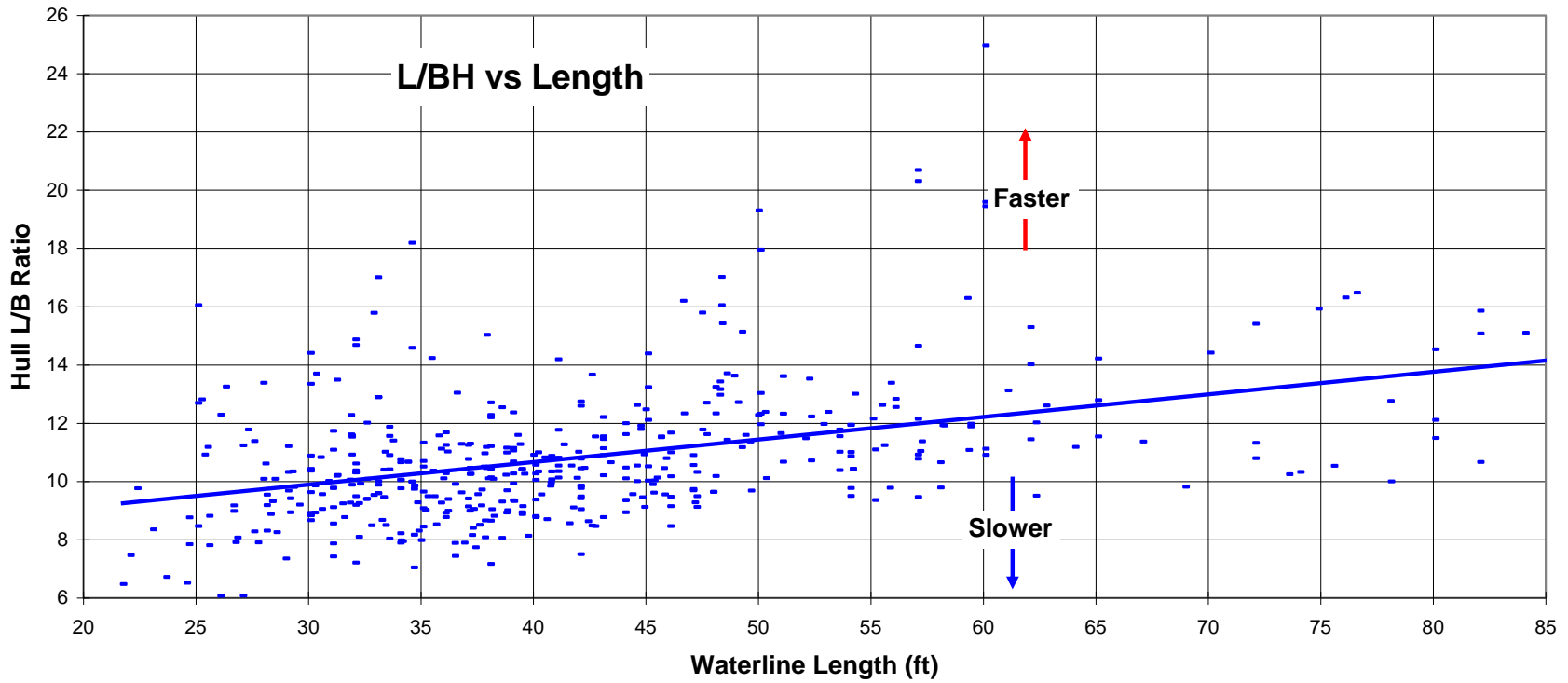

Waterline Length divided by Hull Beam vs. Waterline Length
Cruising and Racing Catamarans

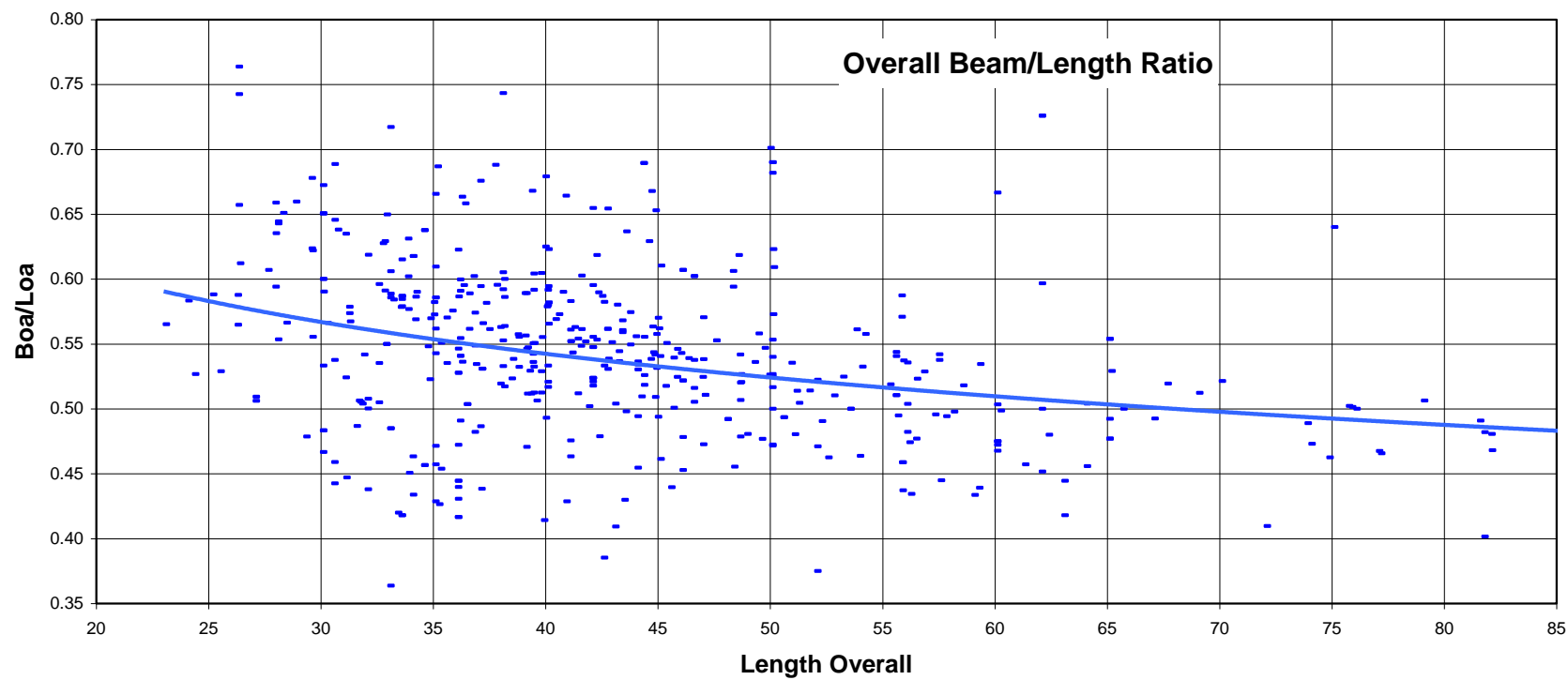

Overall Beam Divided by Overall Length
Cruising and Racing Catamarans

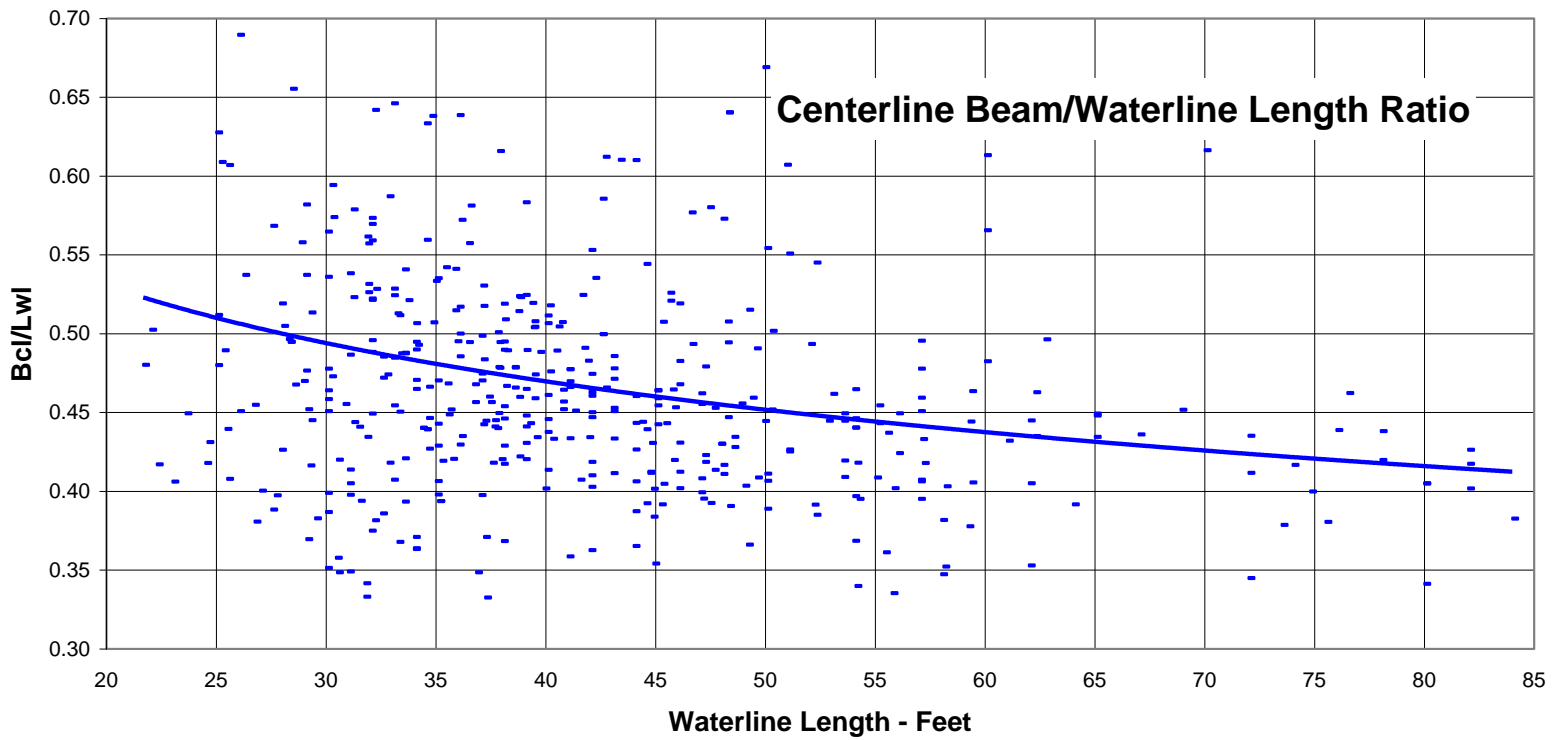

**Distance Between Hull Centerlines vs. Waterline Length
Cruising and Racing Catamarans**

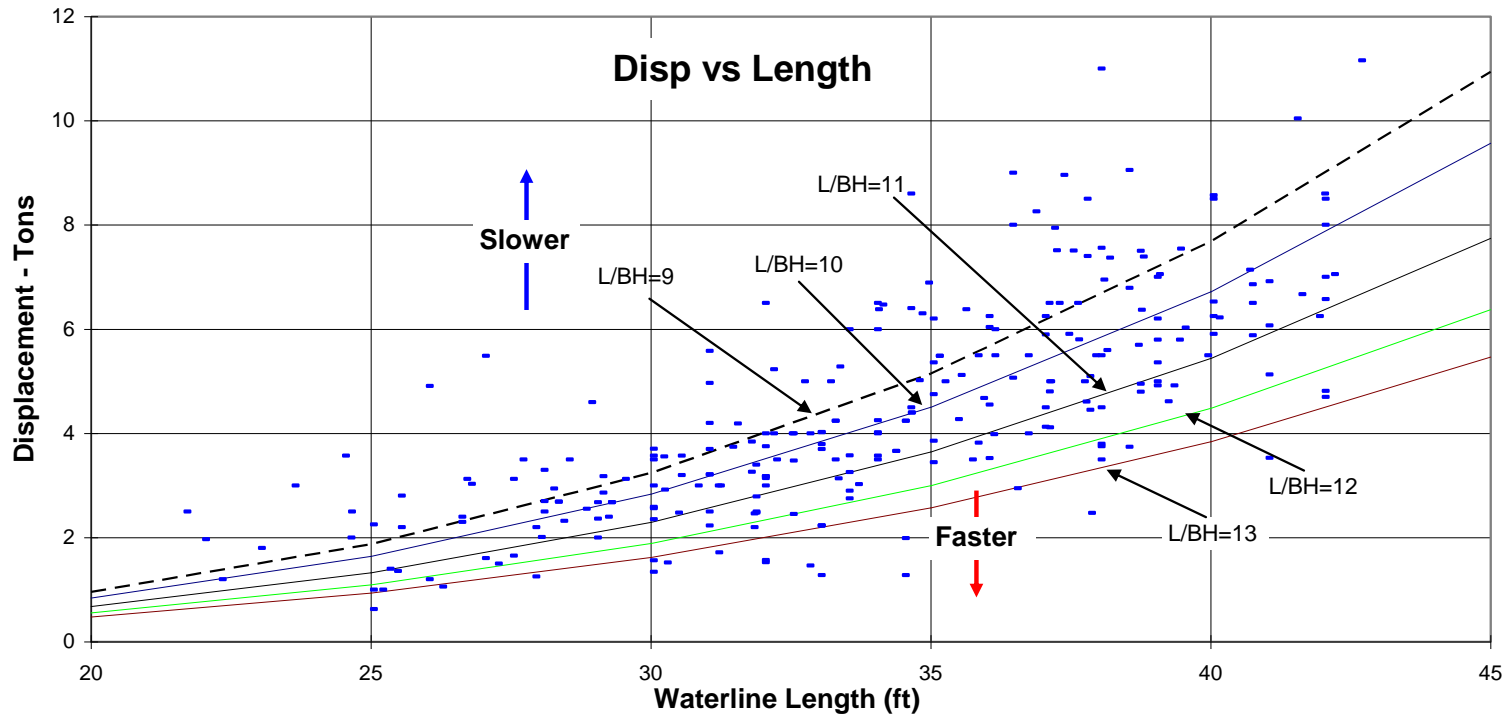

Displacement vs. Waterline Length
Cruising and Racing Catamarans Under 45 Feet

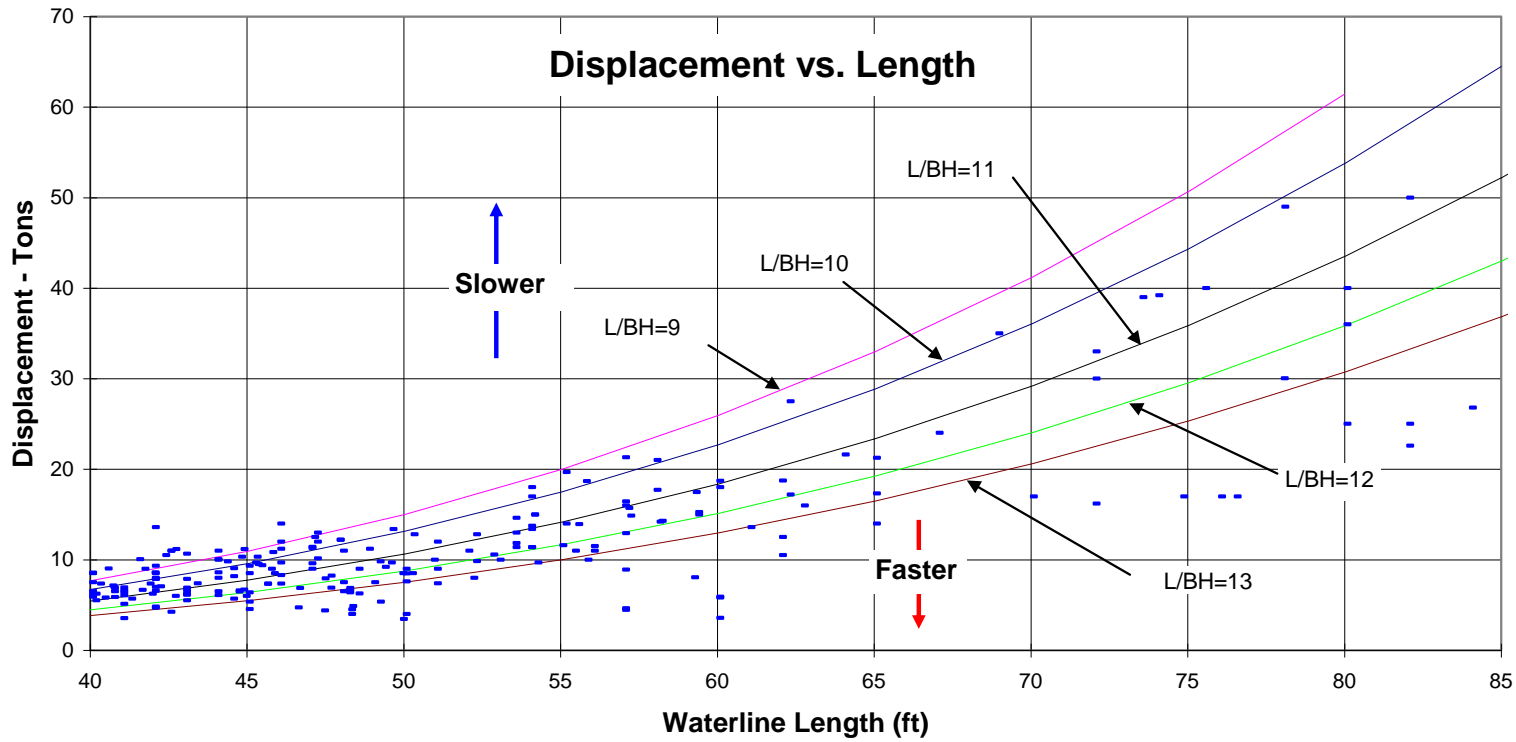

**Displacement vs. Waterline Length
Cruising and Racing Catamarans Over 40 Feet**

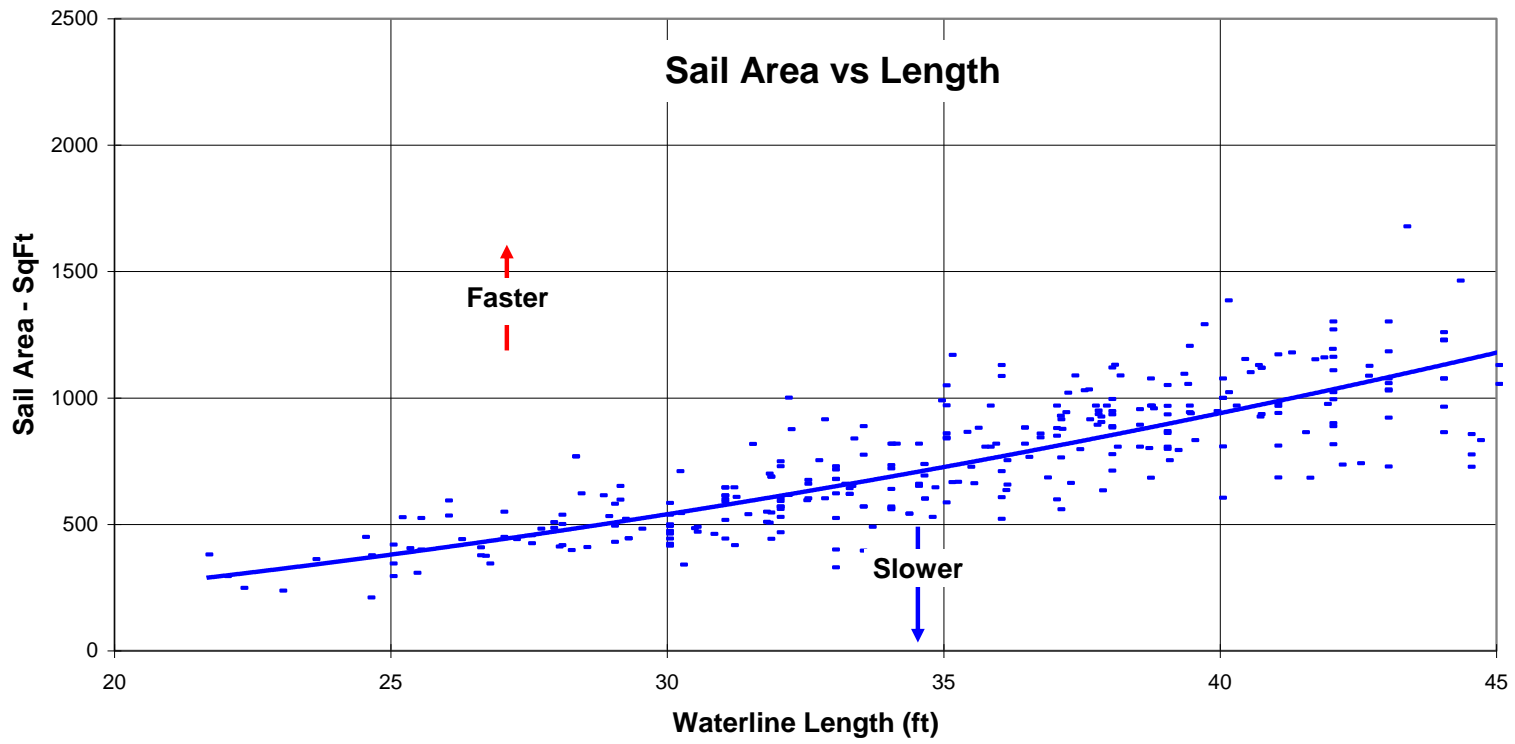

Sail Area vs. Waterline Length
Cruising and Racing Catamarans Under 45 Feet

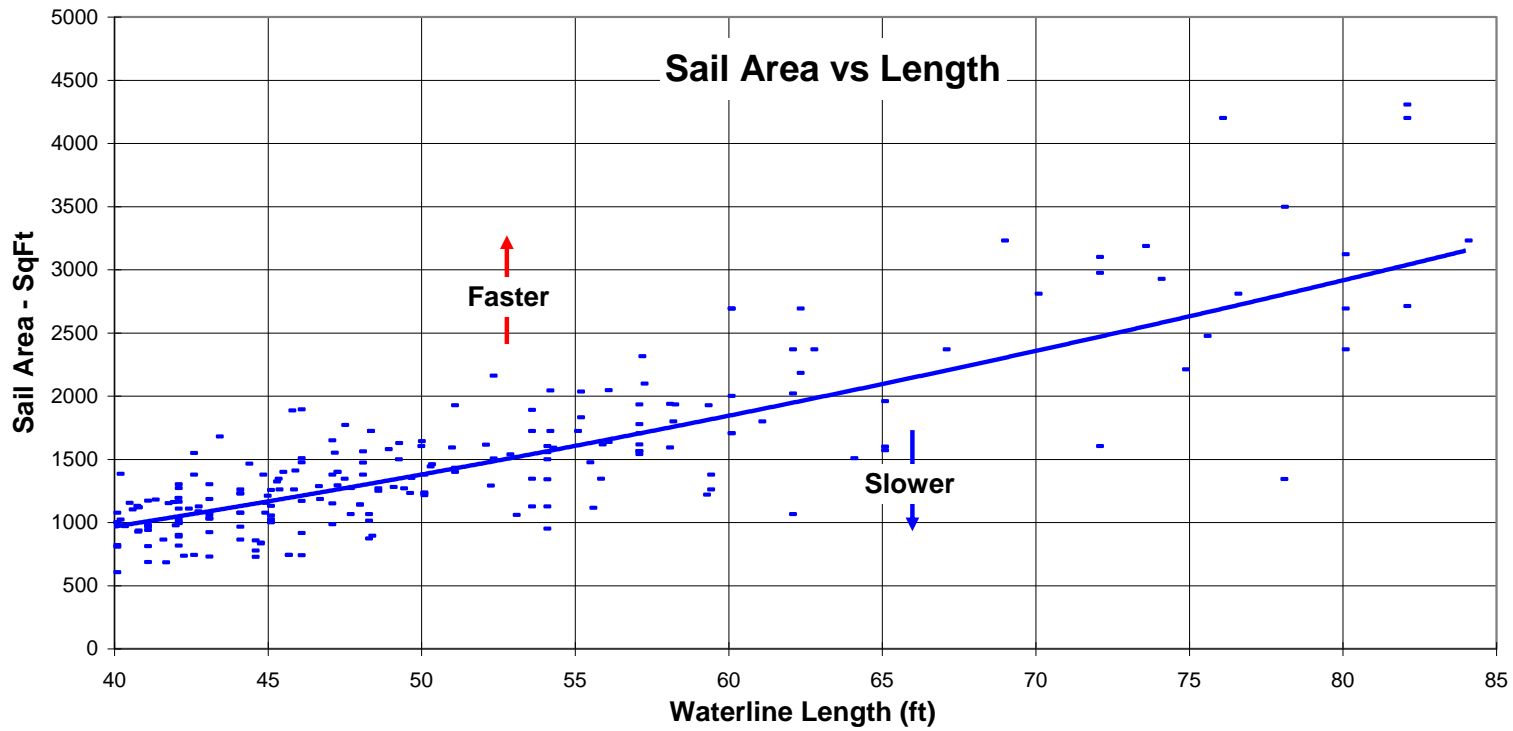

Sail Area vs. Waterline Length
Cruising and Racing Catamarans 40-85 Feet

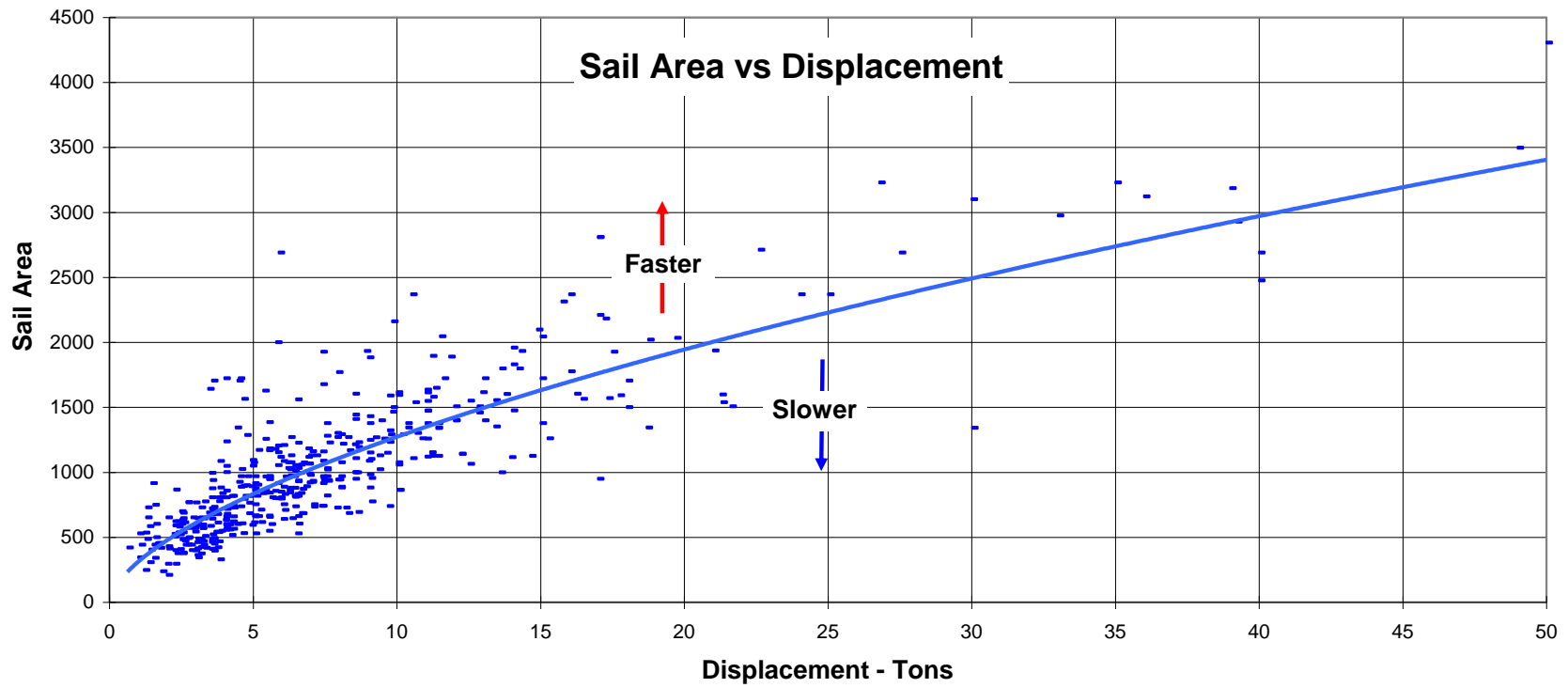

Sail Area Vs. Displacement
Cruising and Racing Catamarans

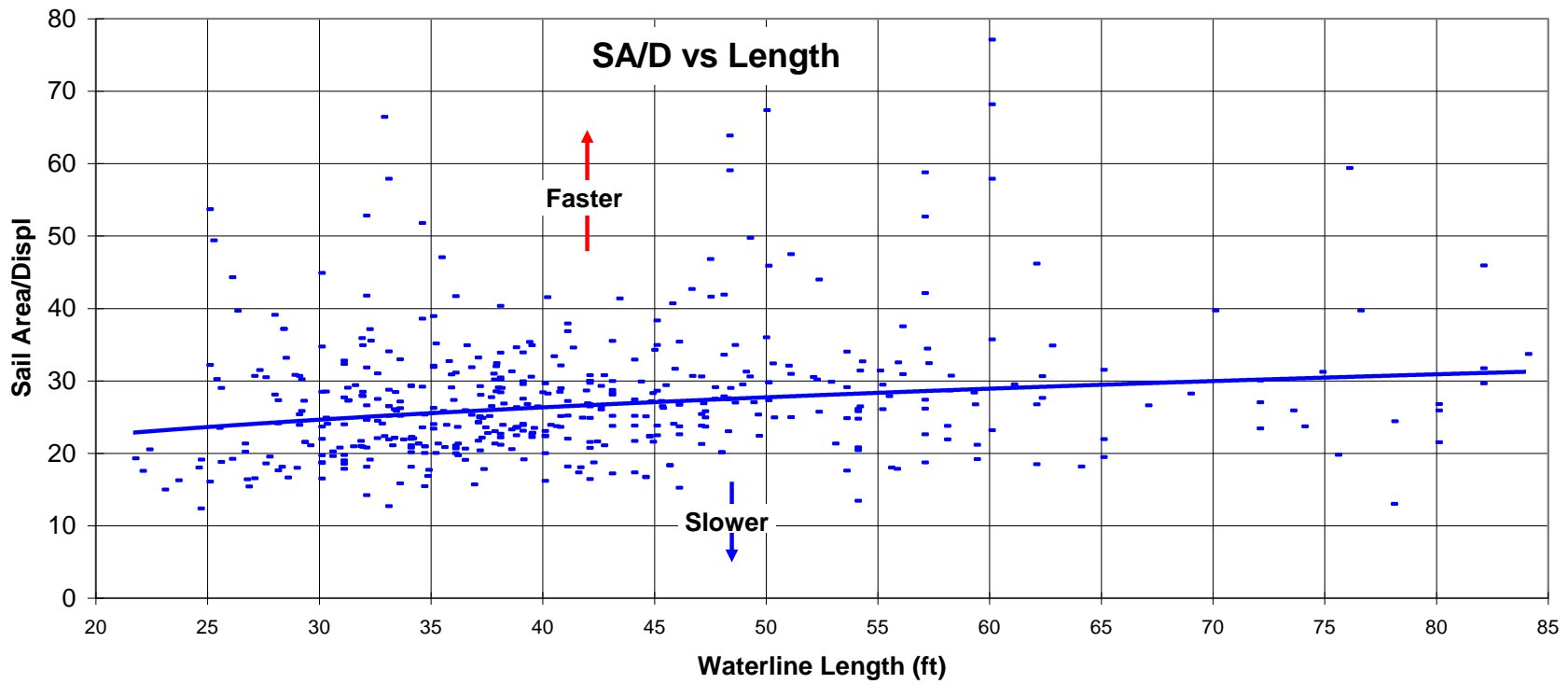

Sail Area/Displacement Ratio vs. Waterline Length
Cruising and Racing Catamarans

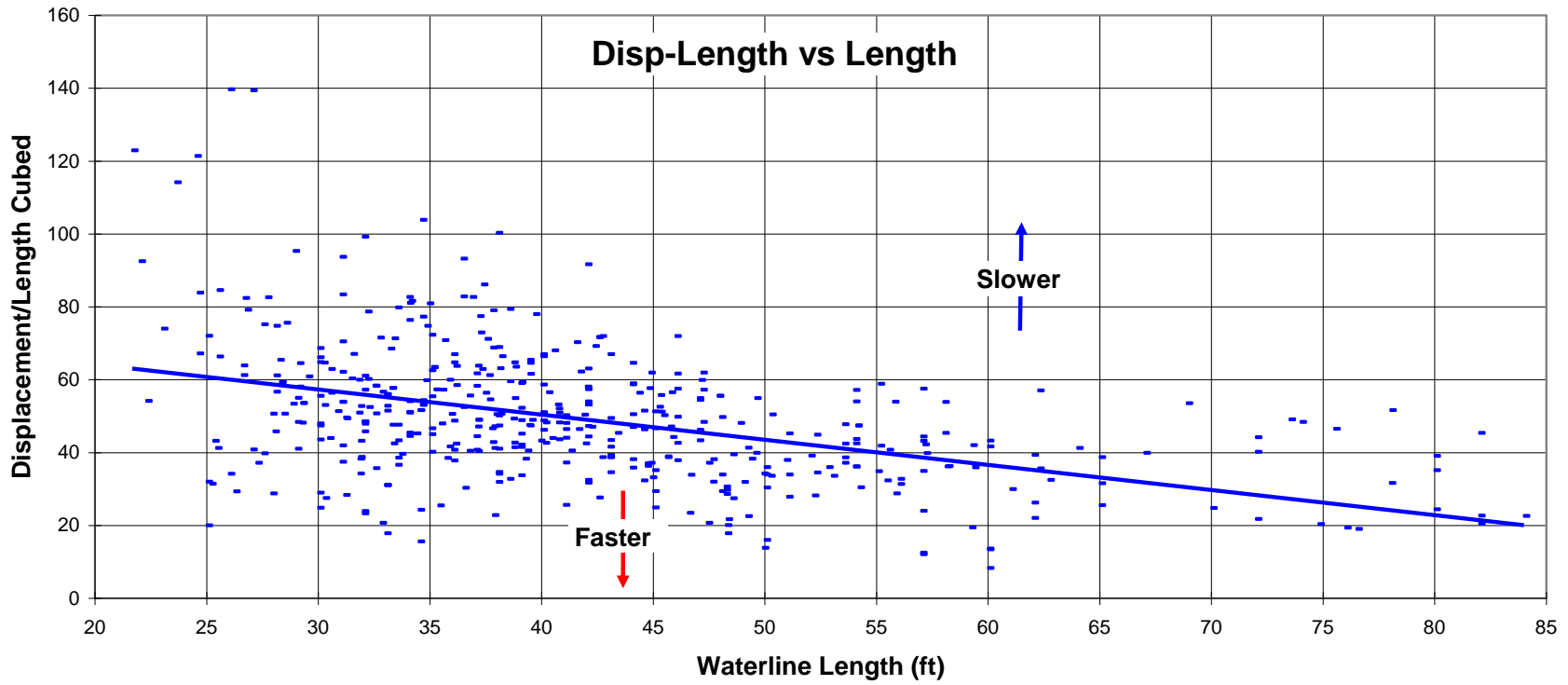

Displacement-Length vs. Waterline Length
Cruising and Racing Catamarans

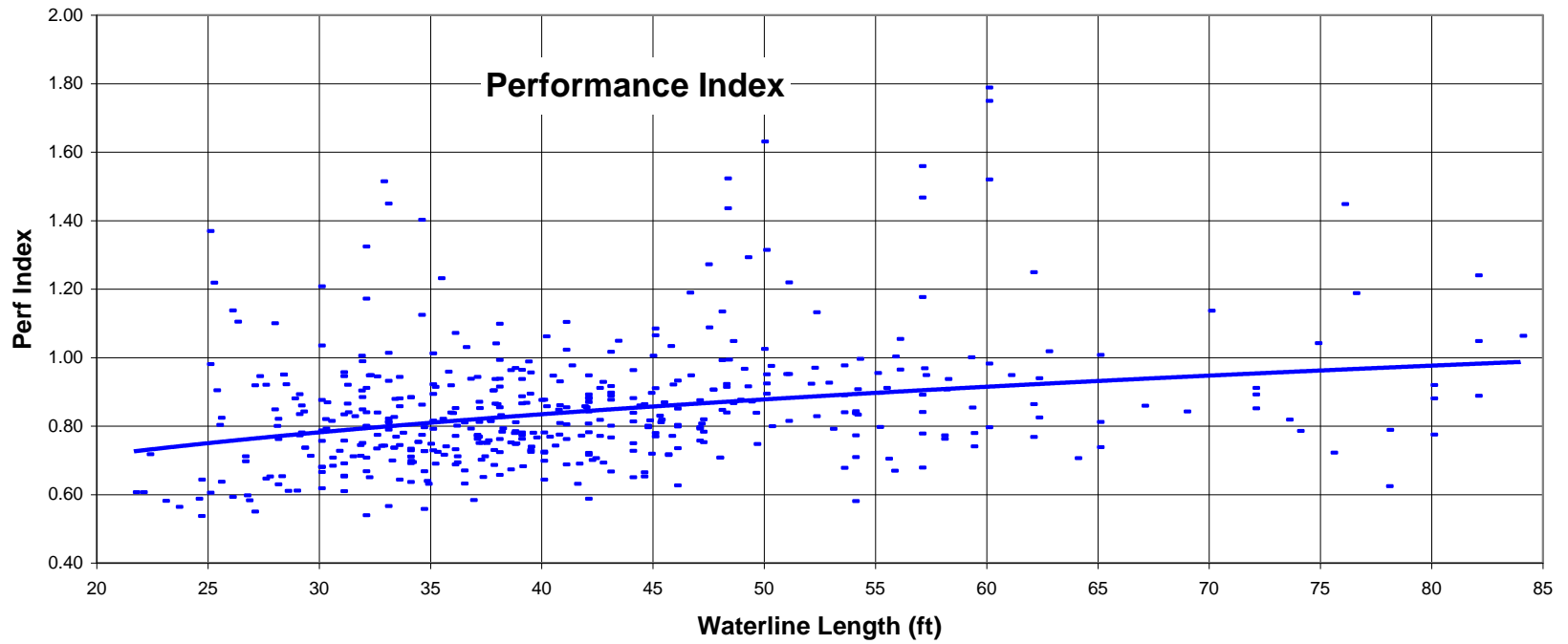

**Performance Index vs. Waterline Length
Cruising and Racing Catamarans**

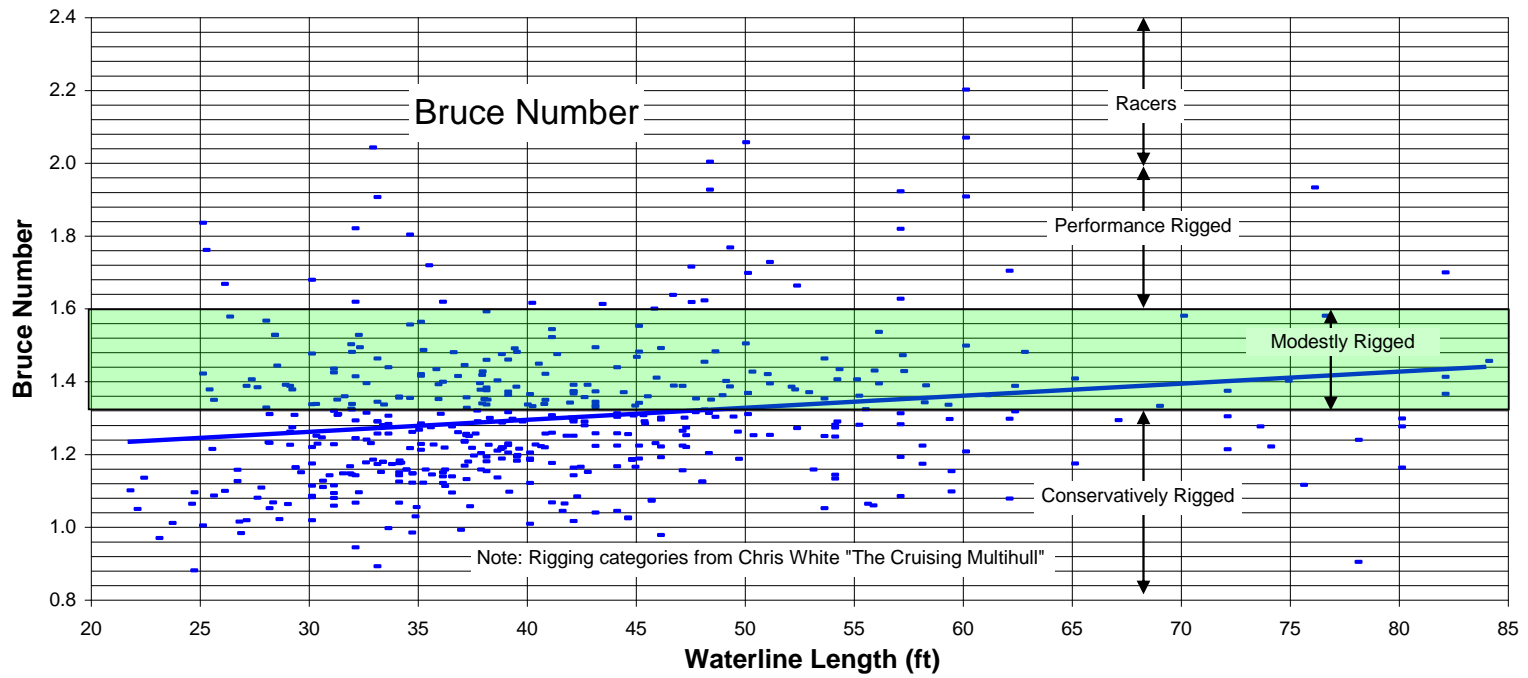

**Bruce Number vs. Waterline Length
Cruising and Racing Catamarans**

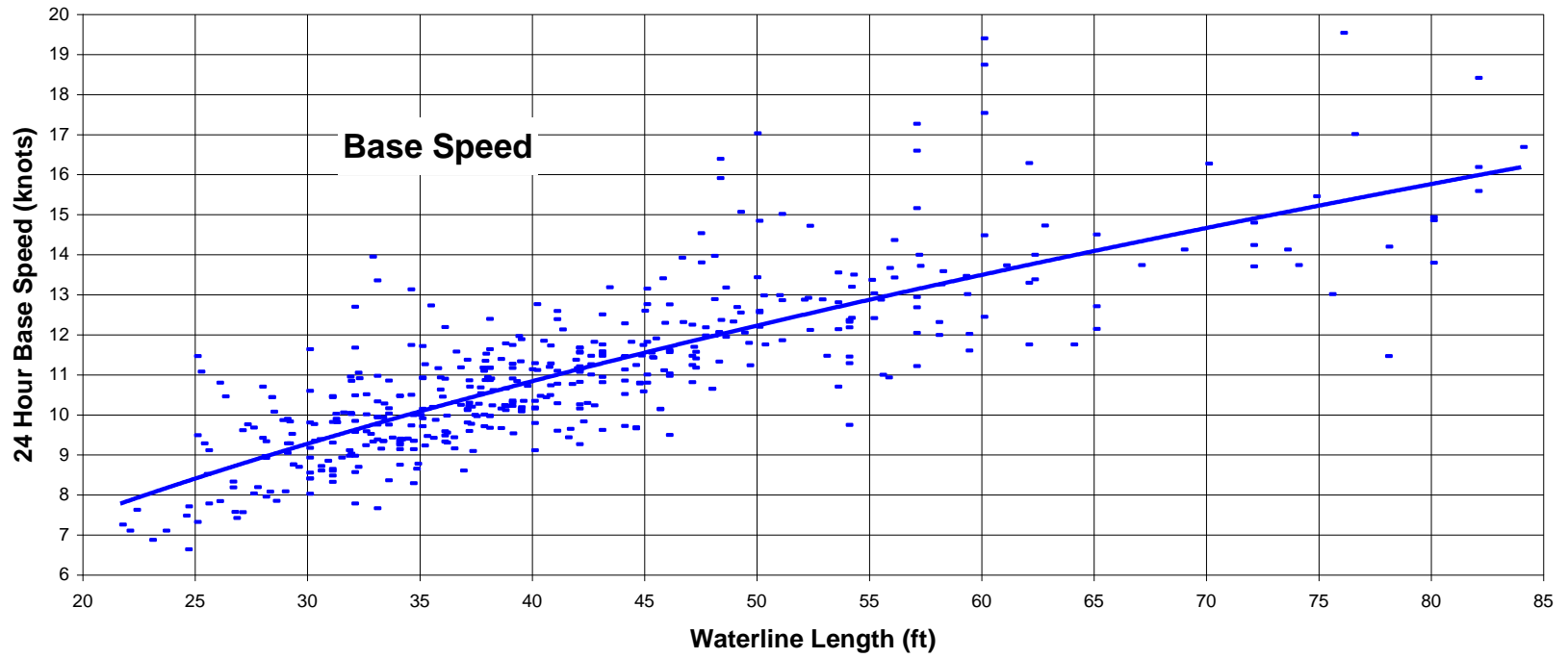

**Base Speed vs. Waterline Length
Cruising and Racing Catamarans**

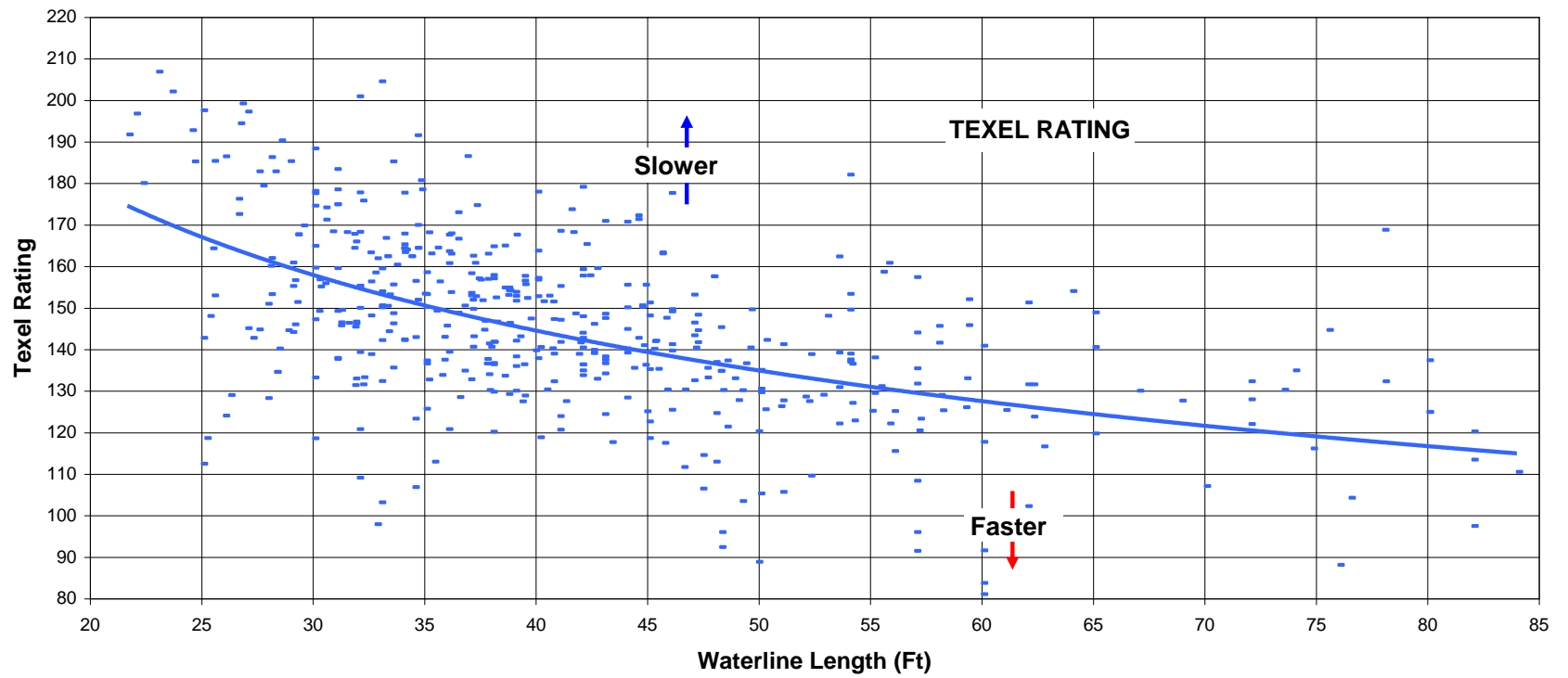

**Texel Rating vs. Waterline Length
Cruising and Racing Catamarans**

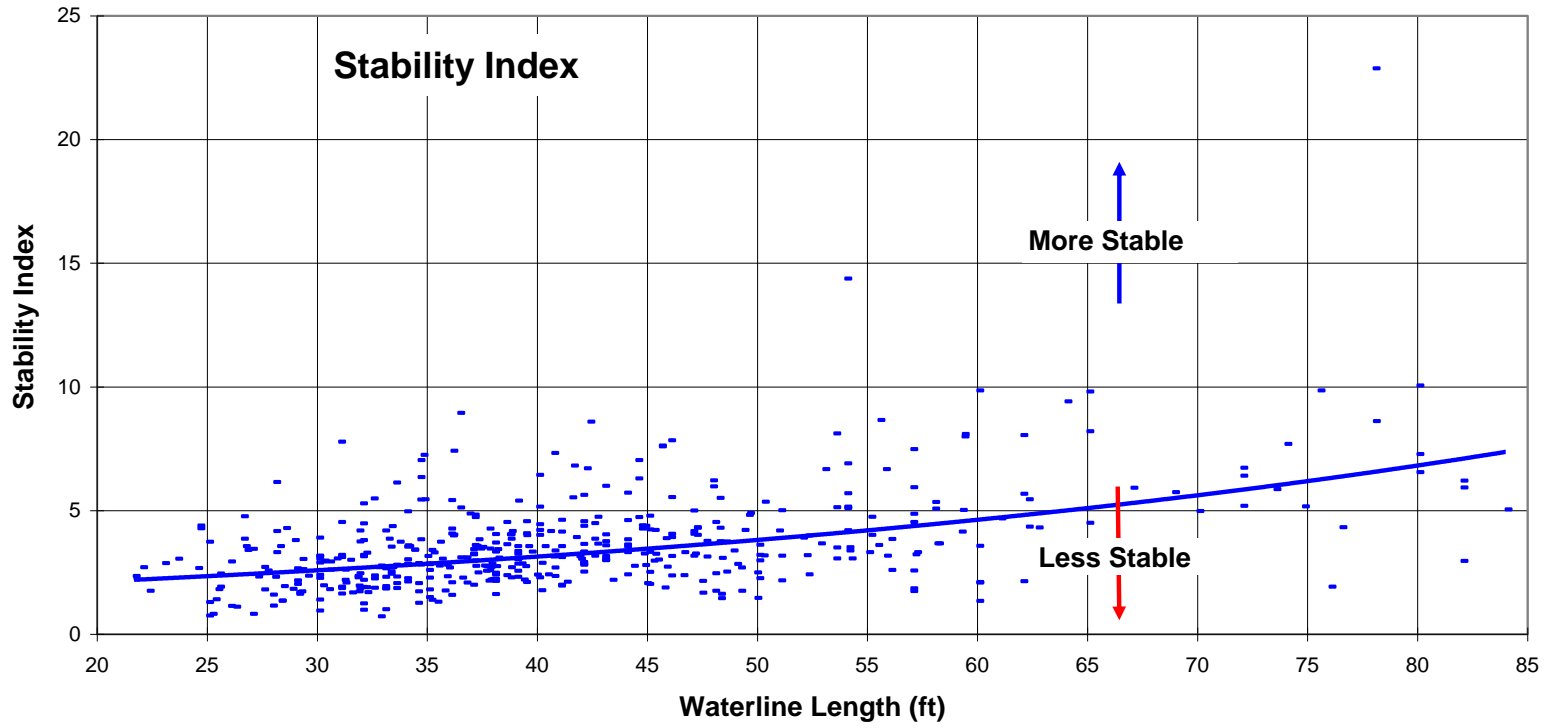

**Stability Index vs. Waterline Length
Cruising and Racing Catamarans**

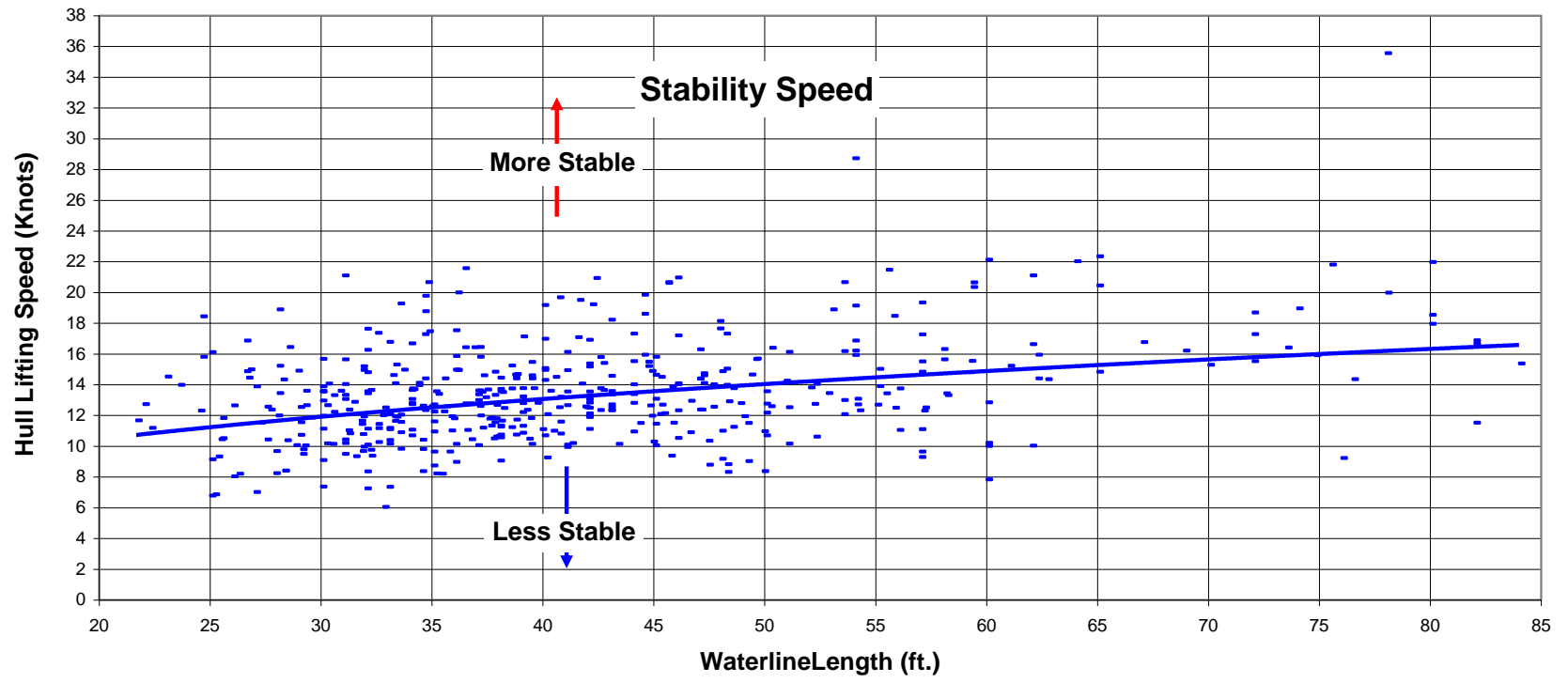

**Stability Speed vs. Waterline Length
Cruising and Racing Catamarans**